

**City of Perris**  
**Department of Development Service**  
**Office of the Fire Marshal**  
**135 North “D” Street, Perris CA. 92570**  
**Phone: (951) 443-1029 Fax: (951) 943-3293**

## **High Piled Combustible Storage Guideline 2016 CODES**

### **PURPOSE**

The intent of this guideline is to provide the requirements for the protection of high-piled storage (HPS) for a variety of commodities. HPS increases the potential fire hazard within a structure by increasing the vertical height of storage and by providing stability of storage (e.g., rack and automated storage) in a fire situation. The following requirements will ensure that the minimum measures required by code have been taken to provide for the public safety and that the required protection of these commodities has been designed in accordance with Chapter 32 of the 2016 California Fire Code (CFC), the 2016 California Building Code (CBC) and locally adopted ordinances enforced by Office of the Fire Marshal (OFM).

### **SCOPE**

This guideline provides the requirements for all HPS within the City of Perris.

### **DEFINITIONS**

#### *High-Piled Combustible Storage*

The storage of combustible materials in closely packed piles, on pallets, in racks, or on shelves where the top of storage is greater than 12 feet in height. High-piled combustible storage also includes certain high-hazard commodities, such as rubber tires, Group A plastics, flammable and combustible liquids, idle pallets, and similar commodities where the top of storage is greater than 6 feet in height. CFC 3202

Note: To be considered non-high pile combustible storage for high hazard commodities  $\leq 6$  feet there cannot be any storage above it.

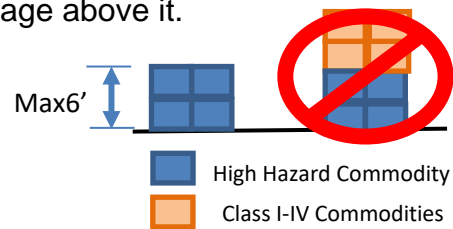

### *High-Piled Storage Area*

An area within a building that is designated, intended, proposed, or actually used for high-piled combustible storage. For purposes of selecting the applicable fire protection requirement row in Table 3206.2:

- This area shall include the “footprint” of the actual storage array (racks, shelves, fixtures, or pallets), inclusive of aisles within the storage area(s). When individual storage arrays are separated by less than 15-foot spaces, the spaces shall be considered aisles and shall be included in a single storage area footprint. When individual storage arrays are separated by more than 15-foot spaces, the individual arrays shall be considered separate storage areas with their own footprint calculation. CFC 3206.2
- Each storage area shall also include a 48-inch perimeter aisle calculated in the footprint. This additional perimeter aisle is not required for areas that abut to a wall. The aisle is the space between the racks not at the end of the rack.
- For multiple storage areas within a building, the aggregate of all high-piled storage areas shall be used for selecting the applicable row in Table 3206.2, unless such areas are separated from each other by a one-hour rated fire barrier wall constructed in accordance with Section 706 of the California Building Code (CBC). Openings in such walls shall be protected by fire assemblies having a one-hour fire-protection rating. CFC 3206.3.2.1.

### *Rack Storage*

A combination of vertical, horizontal, and diagonal members that support stored materials. Racks can be fixed or portable. NFPA13 Section 3.9.3.7.

### *Open Rack*

Racks without shelving or with shelving in racks that are fixed in place with shelves having a solid surface and shelf area equal or less than 20 ft<sup>2</sup> or with shelves having a wire mesh, slatted surface, or other material with openings representing at least 50 percent of the shelf area including the horizontal area of the rack members and where the flue spaces are maintained.

### *Shelf Storage*

Storage on shelves less than 30 inches deep with the distance between shelves not exceeding three feet vertically. For larger shelves and other storage arrangements see *Rack Storage*. 2013 NFPA 13 Section 3.9.2.6

### *Solid Shelving*

Shelving that is solid, slatted, mesh, or grated, or of other construction and less than 50% open located within racks that obstruct sprinkler water penetration through the racks. Within the codes that regulate HPS there are two different thresholds when the size of shelf is considered solid; the Fire Code specifies 32 ft<sup>2</sup> while NFPA 13 specifies 20 ft<sup>2</sup>. OFM's interpretation is that in a non-sprinklered building 32 ft<sup>2</sup> applies; in a sprinklered building 20 ft<sup>2</sup> applies. In sprinklered buildings two factors are used to determine if the shelf is considered solid; the construction type of the shelf and the size of the product that will be stored on the shelf. If the item stored has a horizontal area that exceeds 20 ft<sup>2</sup> in size the shelf is considered solid regardless of the construction of the shelf. As an example the HPS uses wire mesh shelves with an opening greater than 50%. The commodity being stored is on a non-standard pallet of 4' deep by 6' wide, total horizontal size = 24 ft<sup>2</sup>. The shelving would be considered solid since the commodity exceeds 20 ft<sup>2</sup> irrespective that the shelf is wire mesh.

## **SUBMITTAL REQUIREMENTS**

### **1. General**

At the time of permit application, plans and specifications, including but not limited to the information listed below, shall be submitted for review and approval. For certain HPS reviews, the services of a design professional familiar with the requirements contained in CFC Chapter 32 may be of great assistance. All new plan submittals and revisions will consist of **3** plan hard copies. Plans shall be submitted with the following information per CFC 3201.3 Items #1-14:

- A. A letter of intent containing a detailed description of the products to be stored and the description of all containers, pallets, and packaging materials. This letter must also include a detailed description of the storage methods (racks, shelves, pallets), the total storage area in square feet, maximum storage height, and aisle widths. An authorized officer of the company or business must sign this letter. The letter shall be copied onto the plans.
- B. A scaled site plan that shows the entire building, including all fire access lanes, fire hydrants, fire department connection, and fire sprinkler risers. CFC 3206.6.
- C. A scaled floor plan of the building showing locations and dimensions of the HPS area, location of the racks, and access doors to the storage area.
- D. The maximum desired/proposed storage height for each designated storage area per array. This height is measured from the finished floor to the highest point of the commodity stored (not shelf level).

- E. The number of tiers within each rack.
- F. The commodity clearance between the top of storage and the sprinkler deflector for each storage arrangement.
- G. Aisle dimensions between each storage array. Aisles are measured from the actual edge of the commodity to commodity, not rack to rack.
- H. Maximum pile volume for each storage array for solid pile and shelf-storage.
- I. The location and classification of different commodity classes. In sprinklered buildings with multi-tenant spaces, where the HPS area is less than 12,001 ft<sup>2</sup> and the building does not have access doors spaced per CFC 3206.6 and smoke & heat vents are not provided, the plan shall show one of the following:
  - Once verification is made, identify the full height wall between the adjacent tenant space is a minimum of a one-hour fire barrier per CBC Section 707, or
  - Identify all HPS areas in all adjacent tenant spaces. The aggregate of all areas of HPS within the building shall be used to determine fire protection and life safety features per Table 3206.2. The protection required by Table 3206.2 will be based on the individual HPS areas commodity classification and extends the lesser of 15 feet in all direction or to a full height partition.

In sprinklered buildings with multi-tenant spaces, where the HPS area is > 12,000 ft<sup>2</sup> the plan only needs to show the protection and life safety requirements per Table 3206.2 for the new HPS area.

- J. The location of commodities that is banded or encapsulated.
- K. The dimension and location of the transverse and longitudinal flue spaces.
- L. Identify the sprinkler design. The sprinkler design requirements are based on commodity type, aisle width, and sprinkler temperature rating as outlined in 2013 NFPA 13, Chapter 12-18 (e.g., .45/3000 with 286-degree heads). A complete sprinkler design shall be submitted under a separate Service Request number by a C16 licensed contractor.

If the sprinkler design is only provided for the HPS area while the surrounding sprinklers are of a different design, identify the sprinkler protection area for the HPS; insure it extends the lesser of 15 feet in all

direction or to a full height partition. NOTE: The 15 feet begins at the outer most portion of the required aisle as set forth in CFC 3206.9.1.1.

- M. The location of all steel columns in relationship to the racks. All steel columns located within a rack flue space or immediately adjacent to a rack in an aisle may require protection. See 2013 NFPA 13, Section 16.1.4, 17.1.4, or 18.2.1
- N. The location, make, model, type, and automatic link temperature of the automatic/manual release smoke vents. In sprinklered buildings, the fusible links for smoke and heat vents shall operate at a temperature no less than 100 degrees and no more than 200 degrees above the sprinkler rating. In non-sprinklered buildings, the fusible links shall operate between 100 and 220 degrees above the ambient temperature. CFC 910.3.2.3 Gravity-operated drop-out vents shall operate at 500 degrees per CFC 910.3.2.1.

Note: New construction shall only use approved/labeled smoke vents as specified by CFC 3206.7. Required smoke vents in existing structures (constructed under the 1998 or previous codes) shall be inspected for proper operation (manual & automatic) and proper link temperature by an independent qualified contractor. Non-required existing vents shall be either treated as a required vent or shall have the automatic and manual mechanism deactivated including the removal of the release handles.

An inspection report by the inspecting contractor shall be provided to OFM prior to plan approval. The report, at a minimum, shall identify the year the building was constructed, a roof plan showing the location of each vent inspected, the fusible link temperature rating, the presence of a manual release mechanism, and the operational status of each vent. Prior to submitting the report to OFM, all identified deficiencies must be corrected and included within the report.

If the smoke vents do not contain manual release devices, and OFM determines that the manual release devices were not specifically required at the time of construction or during any previously approved high piled storage use, then manual release devices will not be required. OFM staff will evaluate all other conditions on a case by case basis during the review process. If this requirement is placed, OFM staff will indicate the requirement adjacent to the OFM approval stamp on the final approved plans from the proposed operation. The vent inspection report shall be copied onto the plans prior to OFM plan approval.

Establishing HPS in an existing building where the building owner can demonstrate that the smoke & heat vents have been maintained and

inspected per NFPA 204 a new inspection report will not be required.

- O. If required, the design (construction), location, and depth of the curtain board assembly, if applicable.
- P. The occupancy group as defined by CBC Chapter 3.
- Q. Pallet/commodity stop details for maintaining the required flue space (see attachment 2-5).
- R. OFM requires High Pile Storage Minimum Information Form (Attachment 9) completed and copied onto the first sheet of the HPS plan.

## **2. California Fire Code Permits—CFC 3201.2**

Plans and specifications shall be submitted to the OFM as indicated elsewhere in this document. All permits will be issued following plan approval and completion of corresponding inspections of the HPS installation. A CFC permit is required when a building or portion thereof is used for high-piled storage exceeding 500 square feet in area (see the definition of high-piled storage area under “Scope”).

## **3. Commodity Classification—CFC 3203**

Commodities shall be classified as Class I, II, III, IV, or High Hazard, in accordance with CFC Chapter 32 and referenced standards.

Plastics shall be classified as Group A, B, or C in accordance with CFC Chapter 32. To determine the proper commodity classification of products with limited quantities of Group A plastics in mixed commodities, use CFC Figure 3203.7.4. This figure identifies the quantity of Group A plastics allowed to be stored in a package, carton, or on a pallet without increasing the hazard and commodity classification to “high hazard”.

The designation and protection features of a high-piled combustible storage area intended for storage of different commodity classes shall be based on the highest hazard commodity stored, except as otherwise provided for by engineering analysis in CFC 3204.2.

*Note:* Flammable liquids, flammable solids, flammable gasses, aerosols, explosives, oxidizers, and reactive materials, etc. fall under the category of hazardous materials and have additional codes that apply. Storage of hazardous materials often shall require submittal and approval of additional plans prior to further review of the high-piled storage plan.

#### **4. General Fire-Protection Provisions—CFC 3206**

Fire-protection features for high-piled storage areas shall be in accordance with CFC Chapter 32 and other nationally recognized standards approved by the OFM. Fire-detection systems, smoke and heat removal, curtain boards, and fire sprinkler design densities shall extend to 15 feet beyond the high-piled storage area or to a permanent partition, whichever is least. CFC 3206.2 The aggregate of all high-piled storage areas within a building shall be used to design the fire protection features found in CFC Table 3206.2 (attached), unless such areas are separated from each other by a one-hour fire barrier wall constructed in accordance with CBC 706. Distinct occupancy groups shall be separated according to CBC 508.

#### **5. Fire Sprinkler Systems—CFC 3206.4**

When fire sprinklers are required by CFC Table 3206.2 or the CBC (or if otherwise provided), the sprinkler system shall be installed in accordance with 2013 NFPA 13 or other applicable NFPA codes. A full description of the tables, figures, and curves in NFPA 13, Section 12 through 18 (Storage), shall be used to determine the design criteria required.

#### **6. Fire Detection Systems—CFC 3206.5**

When fire detection is required by CFC Table 3206.2, an approved automatic fire detection system shall be installed in accordance with 2013 NFPA 72 standard throughout the high-piled storage area. This system shall be installed and monitored as required by CFC 907.

#### **7. Fire Department Access—CFC 3206.6**

When building access is required by CFC Table 3206.2, access roadways shall be provided to within 150 feet of all portions of the exterior walls of the building used for high-piled storage. When access doors are required by CFC Table 3206.2, they shall be provided in each 100 lineal feet or fraction thereof, of the exterior wall that faces the required access roadway. The required access doors shall be distributed such that the lineal distance between adjacent doors does not exceed 100 feet.

#### **8. Smoke and Heat Removal—CFC 3206.7**

When smoke and heat removal are required by CFC Table 3206.2, smoke and heat vents shall be of an approved type and shall operate automatically by a heat response device and contain a manual release roof handle. Vent size shall be in accordance with CFC Table Section 910 (attached.) The fusible link temperature shall be rated as specified in Section 1-N.

Smoke and heat vents are not required when storage areas with an exit access travel distance of 250 feet or less and protected by early suppression

fast response (ESFR) sprinkler systems installed in accordance with 2013 NFPA 13. Smoke vents shall be inspected and maintained in accordance with NFPA 204.

### 9. Draft Curtains

When required by CFC Table 3206.2, draft curtains shall be installed in accordance with CFC 910.3.5.

NOTE: In sprinklered buildings > 50,000 ft<sup>2</sup> that utilizes non-ESFR sprinkler-heads, draft curtains are required per CFC 910.3.5

### 10. Rack Flue Spaces—CFC 3208.3

Requirements for flue spaces within the rack storage are provided in CFC Table 3208.3 (attached). Single and double row racks shall be equipped with a transverse flue space. Either a mechanical means shall be provided to maintain the transverse flue space, or the load beam shall be painted with a 3 inch yellow strip with the words in red that read, “Keep Clear,” as indicated below. Durable vinyl tape or other appropriate material may be used in lieu of paint, or other methods as approved by OFM.

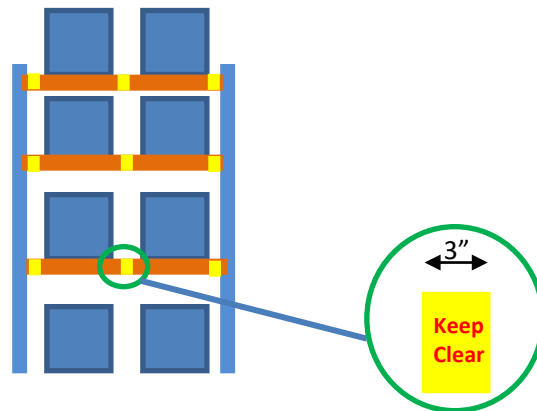

Double-row racks shall be equipped with a pallet/commodity stop along the longitudinal flue space at each level. The stop along the longitudinal flue space shall be steel or other ferrous material ¼” thick and, in the mounted position, shall extend a minimum of 4 inches above the shelf or cross member, or other method (i.e., 9 gauge chain link) approved by the fire code official (CFC 3208.3; see Attachment 5). In double row racks, where products are hand-stacked, chain link shall be securely attached to the rear of both racks. The chain link shall be a minimum of 12 gauge. Attachment method shall be in compliance with Figure 3208.3 (Attachment 6) or other methods as approved by the fire code official.

Alternative acceptable designs are outlined in Attachment 1 through 7. If an alternate design outlined in the attachments is used, the appropriate detail or



details shall be copied onto the plan.

NOTE: Regardless of the design of the pallet stop, the flue space shall be measured from the back of the pallet stop to the back of the pallet stop (see Attachment 8)

Transverse flue space is measured as the distance between the loads, not the distance between the racks. A flue space's net width is a measure of its gross width minus any horizontal obstructions, such as rack uprights, located within the flue space. In other words, a rack upright (typically 3 in. wide) is not considered a flue space, due to the cross bracing used.



Acceptable Method



## 11. ***Solid Piled and Shelf Storage***

Shelf storage, storage in solid piles, solid piles on pallets, and storage in bin boxes not exceeding five feet in any dimension shall be in accordance with CFC 3206 and 3207.

## 12. ***Rack Storage***

Rack storage in a non-sprinklered building shall be in accordance with CFC 3206 and 3208. Rack storage in a sprinklered building shall be in accordance with CFC 3206 and 3208; however the sprinkled protection for solid shelves shall be based on NFPA 13 definition for solid shelves.

## 13. ***Automated Storage***

Automated storage similar to carousel storage shall be in accordance with CFC 3209.

## 14. ***Specialty Storage—CFC 3210***

Record storage facilities used for rack or shelf storage of combustible paper records greater than 12 feet in height shall be in accordance with CFC 3206, 3208, and NFPA 13. Palletized storage of records shall be in accordance with CFC 3207.

## MAINTENANCE

### ***CFC Chapter 9***

All fire and life safety equipment and systems required by the CFC shall be maintained operable at all times. Equipment, devices, and systems shall be regularly tested in accordance with nationally recognized standards, manufacturers' recommendations, and adopted regulations.

The responsibility for inspections, maintenance of the HPS areas as approved, and all fire and life safety equipment and systems required by the CFC shall be the ultimate responsibility of the building owner provided that this responsibility has not been transferred in written form to a management company or other party via a lease agreement or other legal document.

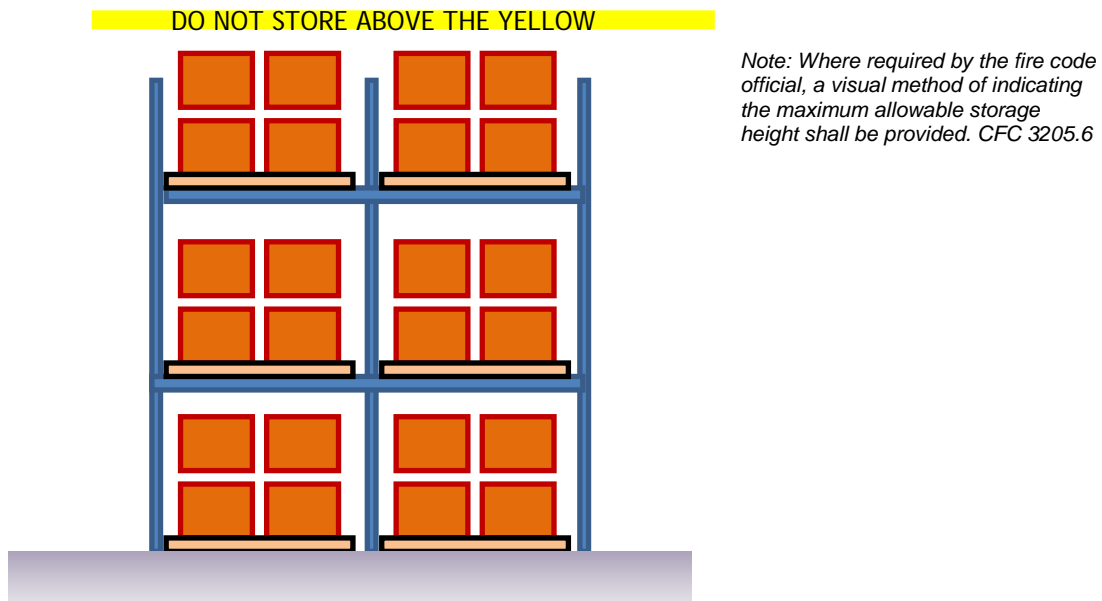

## APPROVED PLANS

### ***CFC Chapter 3201.3***

A copy of the approved HPS plans shall be signed by the OFM Inspector upon completion of final inspection and will serve as the permit. This copy of the plans shall be maintained on site for the life of the HPS system. OFM shall be consulted prior to any changes in the approved/existing/permitted HPS system(s).

## **TECHNICAL ASSISTANCE**

Due to the complexity of the designs specified within the CFC and adopted standards, it may be necessary to obtain the service of a fire protection design professional to assist with developing a protection scheme that meets the requirements of the CFC and other applicable regulations.

**TABLE 3206.2: GENERAL FIRE-PROTECTION AND LIFE-SAFETY REQUIREMENTS**

Commodity Class	Size of High-Piled Storage Area <sup>a</sup> (square feet) (See Sections 3206.2 and 3206.4)	ALL STORAGE AREAS (See Sections 3206, 3207 and 3208) <sup>b</sup>					SOLID-PILED STORAGE, SHELF STORAGE AND PALLETIZED STORAGE (See Section 3207.3)		
		Automatic Fire-extinguishing System (See Section 3206.4)	Fire-detection System (See Section 3206.5)	Building Access (See Section 3206.6)	Smoke and Heat Removal (See Section 3206.7)	Draft curtains (See Section 3206.7)	Maximum Pile Dimension <sup>c</sup>	Maximum Permissible Storage Height <sup>d</sup> (feet)	Maximum Pile Volume (cubic feet)
I-IV	0-500	NR <sup>a</sup>	NR	NR <sup>e</sup>	NR	NR	NR	NR	NR
	501-2,500	NR <sup>a</sup>	Yes <sup>i</sup>	NR <sup>e</sup>	NR	NR	100	40	100,000
	2,501-12,000 Public Accessible	Yes	NR	NR <sup>e</sup>	NR	NR	100	40	400,000
	2,501-12,000 Nonpublic Accessible (Option 1)	Yes	NR	NR <sup>e</sup>	NR	NR	100	40	400,000
	2,501-12,000 Nonpublic Accessible (Option 2)	NR <sup>a</sup>	Yes	Yes	Yes <sup>j</sup>	Yes <sup>j</sup>	100	30 <sup>f</sup>	200,000
	12,001-20,000	Yes	NR	Yes	Yes <sup>j</sup>	NR	100	40	400,000
	20,001-500,000	Yes	NR	Yes	Yes <sup>j</sup>	NR	100	40	400,000
	500,000+ <sup>g</sup>	Yes	NR	Yes	Yes <sup>j</sup>	NR	100	40	400,000
High-hazard	0-500	NR <sup>a</sup>	NR	NR <sup>e</sup>	NR	NR	50	NR	NR
	501-2,500 Public Accessible	Yes	NR	NR <sup>e</sup>	NR	NR	50	30	75,000
	501-2,500 Nonpublic accessible (Option 1)	Yes	NR	NR <sup>e</sup>	NR	NR	50	30	75,000
	501-2,500 Nonpublic accessible (Option 2)	NR <sup>a</sup>	Yes	Yes	Yes <sup>j</sup>	Yes <sup>j</sup>	50	20	50,000
	2,501-300,000	Yes	NR	Yes	Yes <sup>j</sup>	NR	50	30	75,000
	300,001-500,000 <sup>g,h</sup>	Yes	NR	Yes	Yes <sup>j</sup>	NR	50	30	75,000

NR = Not Required

<sup>a</sup> When fire sprinklers are required for reasons other than those in Chapter 32, the portion of the sprinkler system protecting the high-piled storage area shall be designed and installed in accordance with Sections 3207 and 3208.

<sup>b</sup> For aisles, see Section 3206.9.

<sup>c</sup> Piles shall be separated by aisles complying with Section 3206.9.

<sup>d</sup> For storage in excess of the height indicated, special fire protection shall be provided in accordance with Footnote g when required by the chief. See also Chapters 28 and 34 for special limitations for aerosols and flammable and combustible liquids.

<sup>e</sup> Section 503 shall apply for fire apparatus access.

<sup>f</sup> For storage exceeding 30 feet in height, Option 1 shall be used.

<sup>g</sup> Special fire-protection provisions including, but not limited to, fire protection of exposed steel columns; increased sprinkler density; additional in-rack sprinklers, without associated reductions in ceiling sprinkler density; or additional fire department hose connections shall be provided when required by the chief.

<sup>h</sup> High-piled storage areas shall not exceed 500,000 square feet. A two-hour fire wall constructed in accordance with the California Building Code shall be used to divide high-piled storage exceeding 500,000 square feet in area.

<sup>i</sup> Not required when an automatic fire-extinguishing system is designed and installed to protect the high-piled storage area in accordance with Sections 3207 and 3208.

<sup>j</sup> Smoke and heat vents are *not* required when storage areas with an exit access travel distance of 250 feet or less or protected by early suppression fast response (ESFR) sprinkler systems installed in accordance with 2013 NFPA 13.

**TABLE 910.3: REQUIREMENTS FOR DRAFT CURTAINS AND SMOKE AND HEAT VENTS<sup>a</sup> (See Section 3206.7)**

OCCUPANCY GROUP AND COMMODITY CLASSIFICATION	DESIGNATED STORAGE HEIGHT (feet)	MINIMUM DRAFT CURTAIN DEPTH (feet)	MAXIMUM AREA FORMED BY DRAFT CURTAINS (square feet)	VENT- AREA-TO FLOOR-AREA RATIO <sup>c</sup>	MAXIMUM SPACING OF VENT CENTERS (feet)	MAXIMUM DISTANCE TO VENTS FROM WALL OR DRAFT CURTAIN <sup>b</sup> (feet)
Group F-1 and S-1	-	0.2 x H <sup>d</sup> but ≥ 4	50,000	1:100	120	60
Commodity Classification I-IV (Option 1)	≤ 20	6	10,000	1:100	100	60
	> 20 ≤ 40	6	8,000	1:75	100	55
Commodity Classification I-IV (Option 2)	≤ 20	4	3,000	1:75	100	55
	> 20 ≤ 40	4	3,000	1:50	100	50
High-hazard (Option 1)	≤ 20	6	6,000	1:50	100	50
	> 20 ≤ 30	6	6,000	1:40	90	45
High-hazard (Option 2)	≤ 20	4	4,000	1:50	100	50
	> 20 ≤ 30	4	2,000	1:30	75	40

<sup>a</sup> Requirements for rack storage heights in excess of those indicated shall be in accordance with Chapter 32. For solid-piled storage heights in excess of those indicated, an approved engineered design shall be used.

<sup>b</sup> The distance specified is the maximum distance from any vent in a particular draft curtained area to walls or draft curtains which form the perimeter of the draft curtained area.

<sup>c</sup> Where draft curtains are not required, the vent area to floor area ratio shall be calculated based on a minimum draft curtain depth of 6 feet (Option 1.)

<sup>d</sup> “H” is the height of the vent, in feet above the floor.

**TABLE 3208.3: REQUIRED FLUE SPACES FOR RACK STORAGE**

RACK CONFIGURATION	FIRE SPRINKLER PROTECTION		SPRINKLER AT THE CEILING WITH OR WITHOUT MINIMUM IN-RACK SPRINKLERS			IN-RACK SPRINKLERS AT EVERY TIER	NON-SPRINKLERED
	Storage Height		≤ 25 feet		> 25 feet	Any Height	Any Height
			Option 1	Option 2			
Single-row Rack	Transverse Flue Space	Size <sup>b</sup>	3 inch	NA	3 inch	NR	NR
		Vertically Aligned	NR	NA	Yes	NA	
	Longitudinal Flue Space		NR	NA	NR	NR	
Double-row Rack	Transverse Flue Space	Size <sup>b</sup>	6 inch <sup>a,c</sup>	3 inch	3 inch	NR	
		Vertically Aligned	NR	NR	Yes	NA	
	Longitudinal Flue Space		NR	6 inch	6 inch	NR	
Multi-row Rack	Transverse Flue Space	Size <sup>b</sup>	6 inch <sup>c</sup>	NA	6 inch	NR	
		Vertically Aligned	NR	NA	Yes	NA	
	Longitudinal Flue Space		NR	NA	NR	NR	

NR = “not required.” NA means “not applicable.”

<sup>a</sup> Three-inch transverse flue spaces shall be provided at least every 10 feet where ESFR sprinkler protection is provided.

<sup>b</sup> Random variations are allowed, provided that the configuration does not obstruct water penetration.

<sup>c</sup> Transverse flue spaces shall be maintained by methods as approved.

## ATTACHMENT 1

### LOAD BEAM CONFIGURATION NOT REQUIRING PALLET STOPS

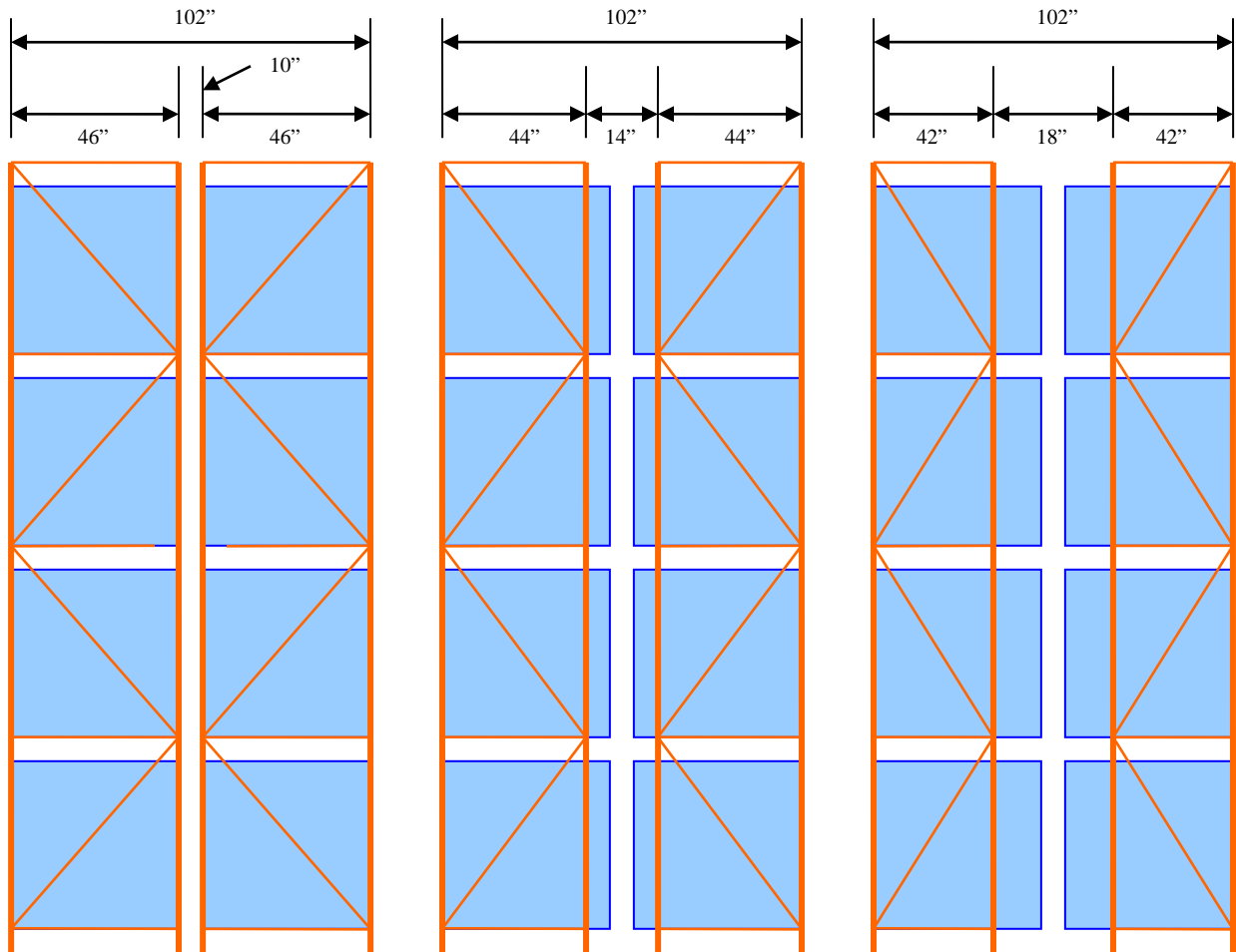

#### NOTES:

1. MAXIMUM PALLET DEPTH 48"
2. STORAGE ON LOAD BEAM ONLY, NO SHELVING, WIRE MESH GRATING, OR PALLET SUPPORTS.
3. 6" FLUE SPACE SHALL BE MAINTAINED AT ALL TIMES.

#### NOTES:

1. WHEN 42" UPRIGHTS ARE UTILIZED WITH AN 18" ROW SPACER AND A TYPICAL 48"x40" PALLET IS USED, NO PALLET STOPS ARE REQUIRED.
2. WHEN 44" UPRIGHTS ARE UTILIZED WITH A 14" ROW SPACER AND A TYPICAL 48"x40" PALLET IS USED, NO PALLET STOPS ARE REQUIRED.
3. WHEN 46" UPRIGHTS ARE UTILIZED WITH A 10" ROW SPACER AND A TYPICAL 48"x40" PALLET IS USED, NO PALLET STOPS ARE REQUIRED.

## ATTACHMENT 2

### STORAGE CONFIGURATION REQUIRING PALLET STOPS

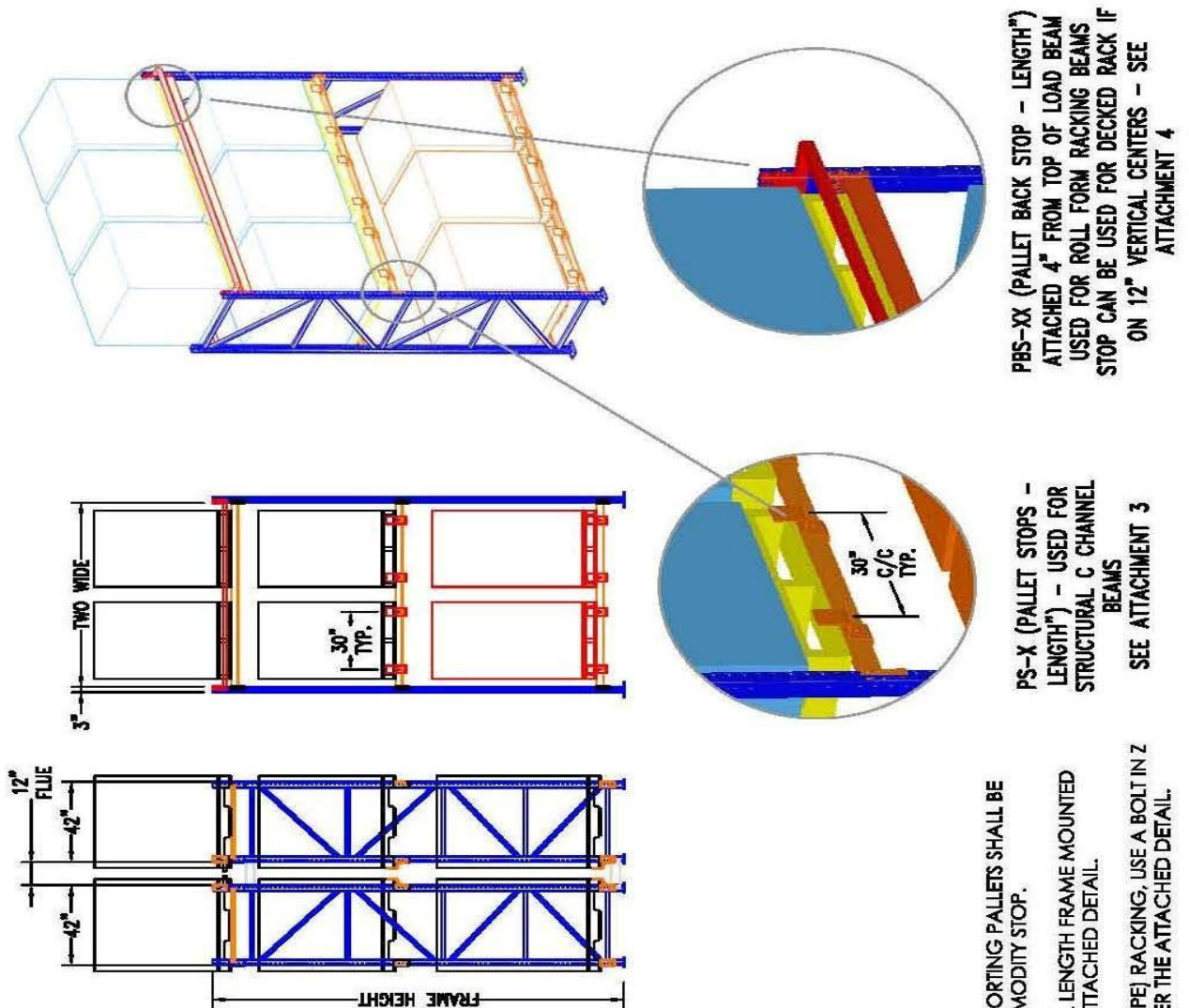

**NOTES:**

RACKS WITH OPEN SHELVES SUPPORTING PALLETS SHALL BE PROVIDED WITH A PALLET / COMMODITY STOP.

FOR ROLL FORM RACKING A FULL LENGTH FRAME MOUNTED SUPPORT IS TO BE USED PER THE ATTACHED DETAIL.

FOR STRUCTURAL (C-CHANNEL TYPE) RACKING, USE A BOLT IN Z TYPE SUPPORT ON 30" CENTERS PER THE ATTACHED DETAIL.

PBS-XX (PALLET BACK STOP - LENGTH") ATTACHED 4" FROM TOP OF LOAD BEAM USED FOR ROLL FORM RACKING BEAMS STOP CAN BE USED FOR DECKED RACK IF ON 12" VERTICAL CENTERS - SEE ATTACHMENT 4

PS-X (PALLET STOPS - LENGTH") - USED FOR STRUCTURAL C CHANNEL BEAMS SEE ATTACHMENT 3

### ATTACHMENT 3

## STRUCTURAL "C" CHANNEL BEAM DETAIL

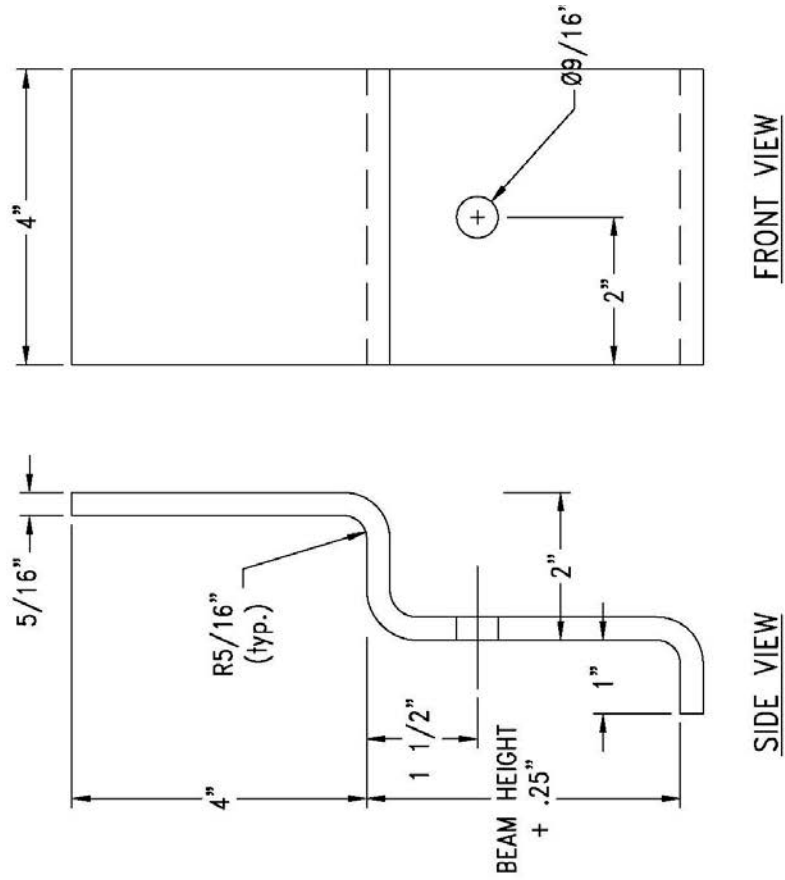



## ATTACHMENT 4

### ROLL FORM RACKING DETAIL

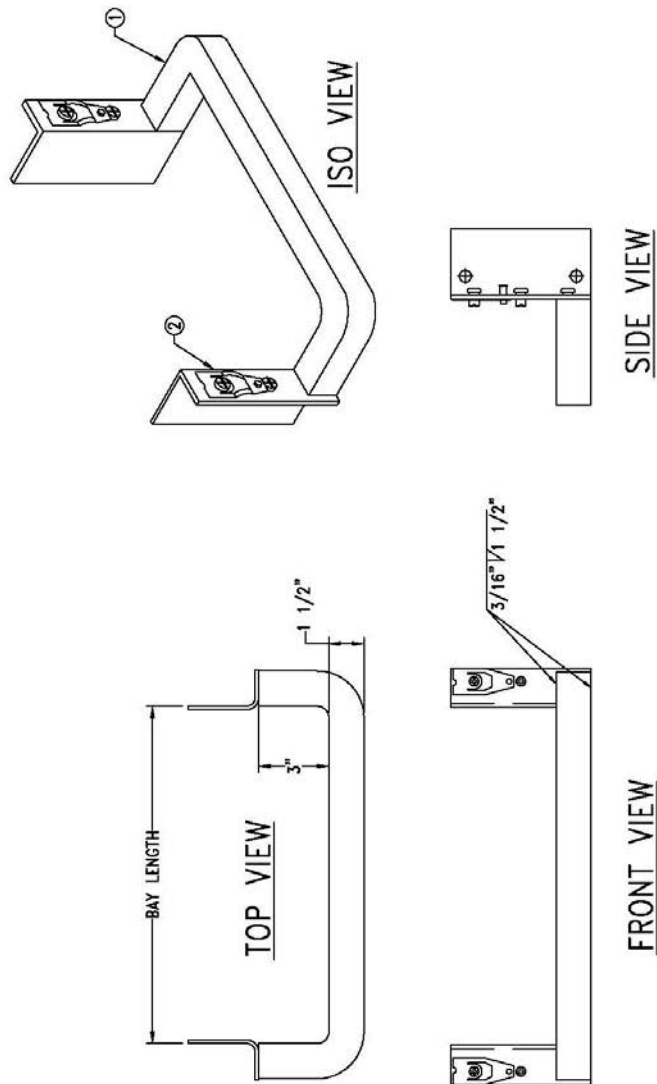

## ATTACHMENT 5

### STORAGE CONFIGURATION FOR HAND STACK RACK

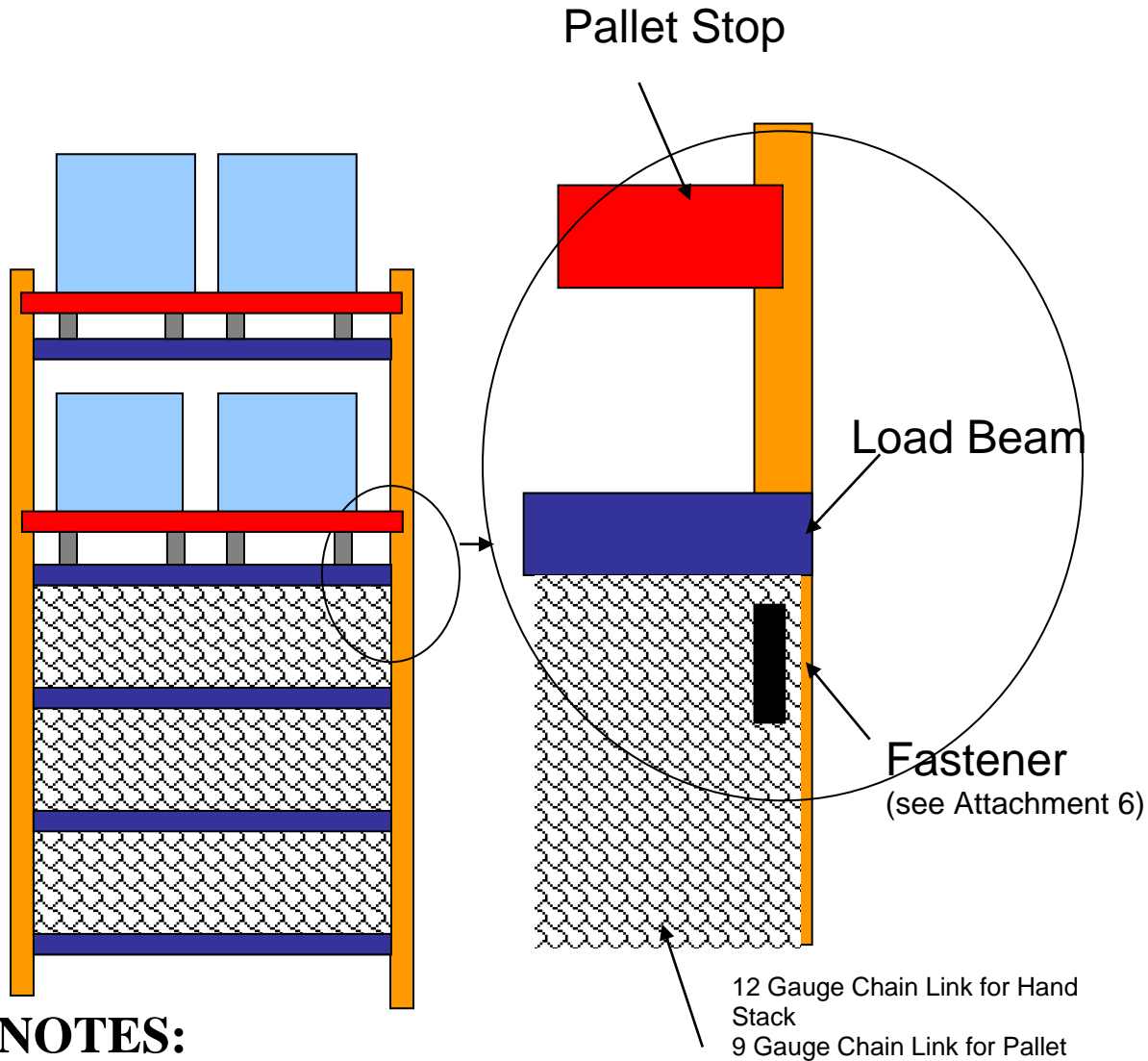

#### NOTES:

HAND STACKING/PICKING RACKS: HAND STACKING NON-PALLETIZED AREAS SHALL BE PROVIDED WITH A MEANS TO ENSURE THAT THE FLUE SPACES ARE MAINTAINED. HAND STACK LOCATION WILL BE SECURED FLUSH TO THE REAR COLUMN OF EACH FRAME AS SHOWN IN ATTACHED DETAIL (SEE ATTACHMENT 6 FOR CHAIN LINK).

9 Gauge Chain Link Fence for Pallet Loads.  
12 Gauge Chain Link for Hand Stack Loads.

## ATTACHMENT 6

### CHAIN LINK ATTACHMENT METHOD DETAIL

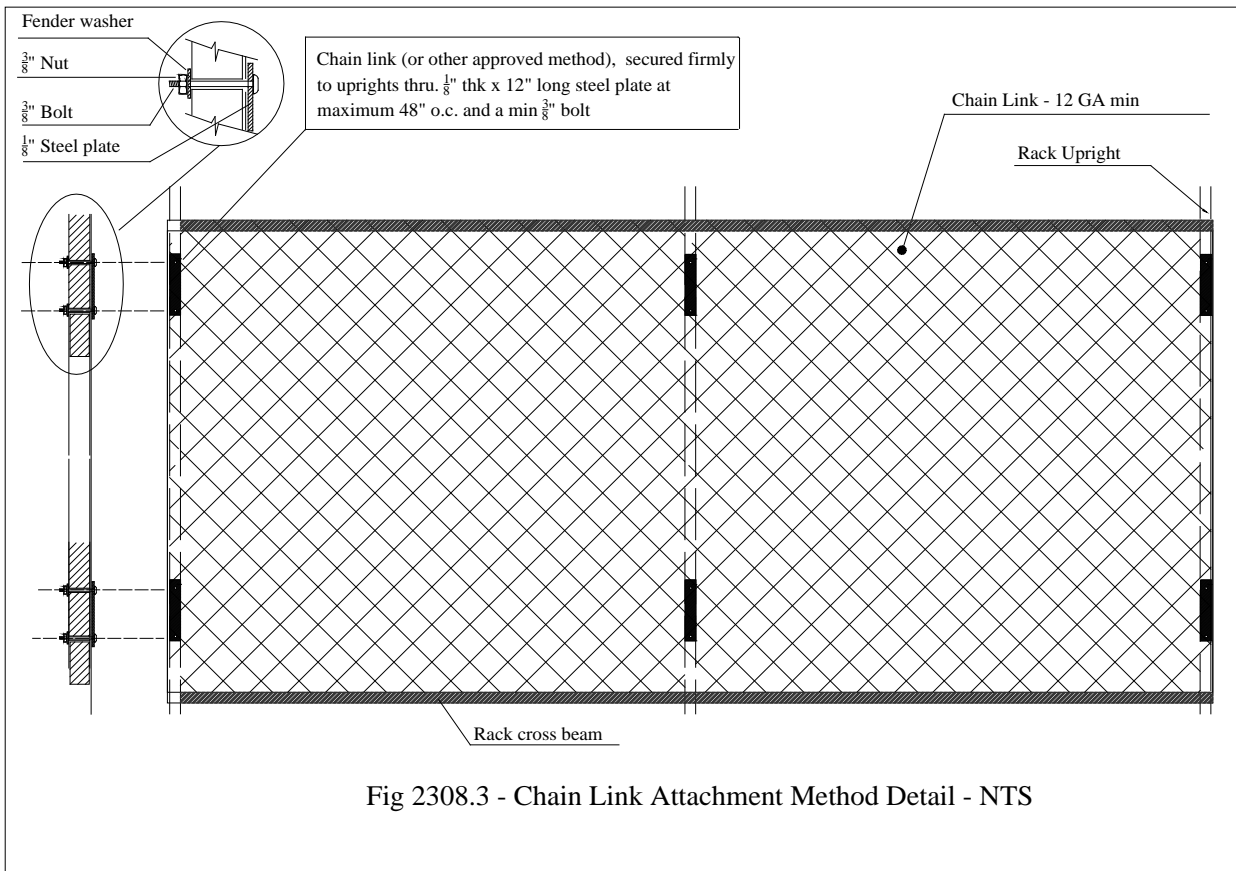

# ATTACHMENT 7

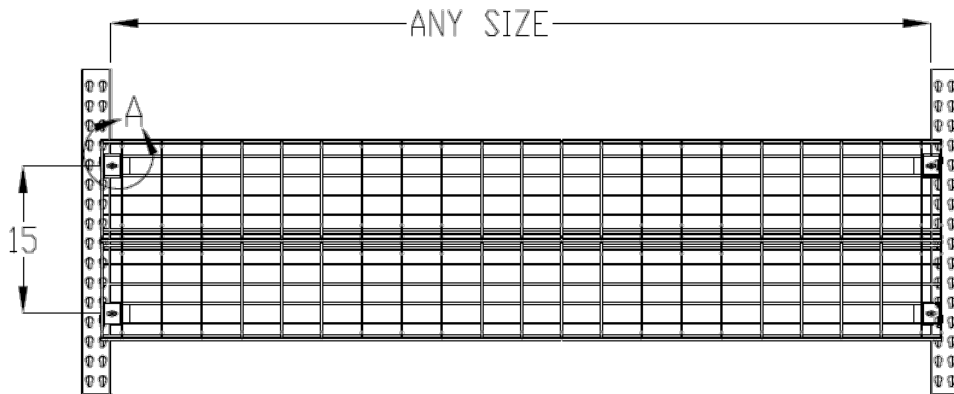

**AISLE  
SHIELD**

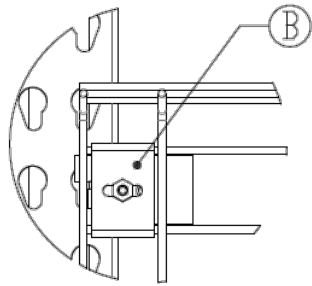

**Method 1**

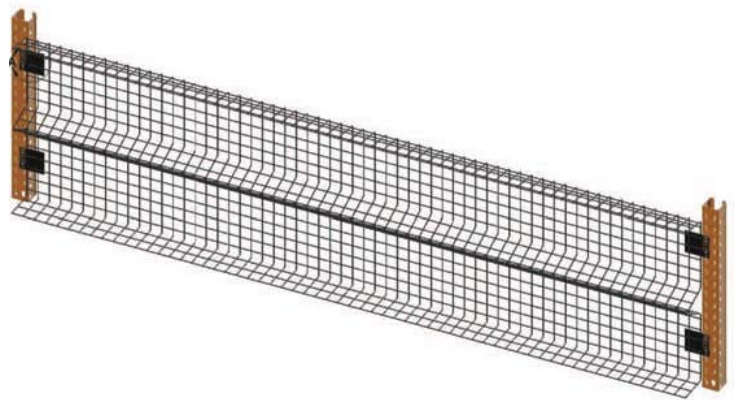

**Method 2**

## ATTACHMENT 8

### Pallet Stop Clear Space

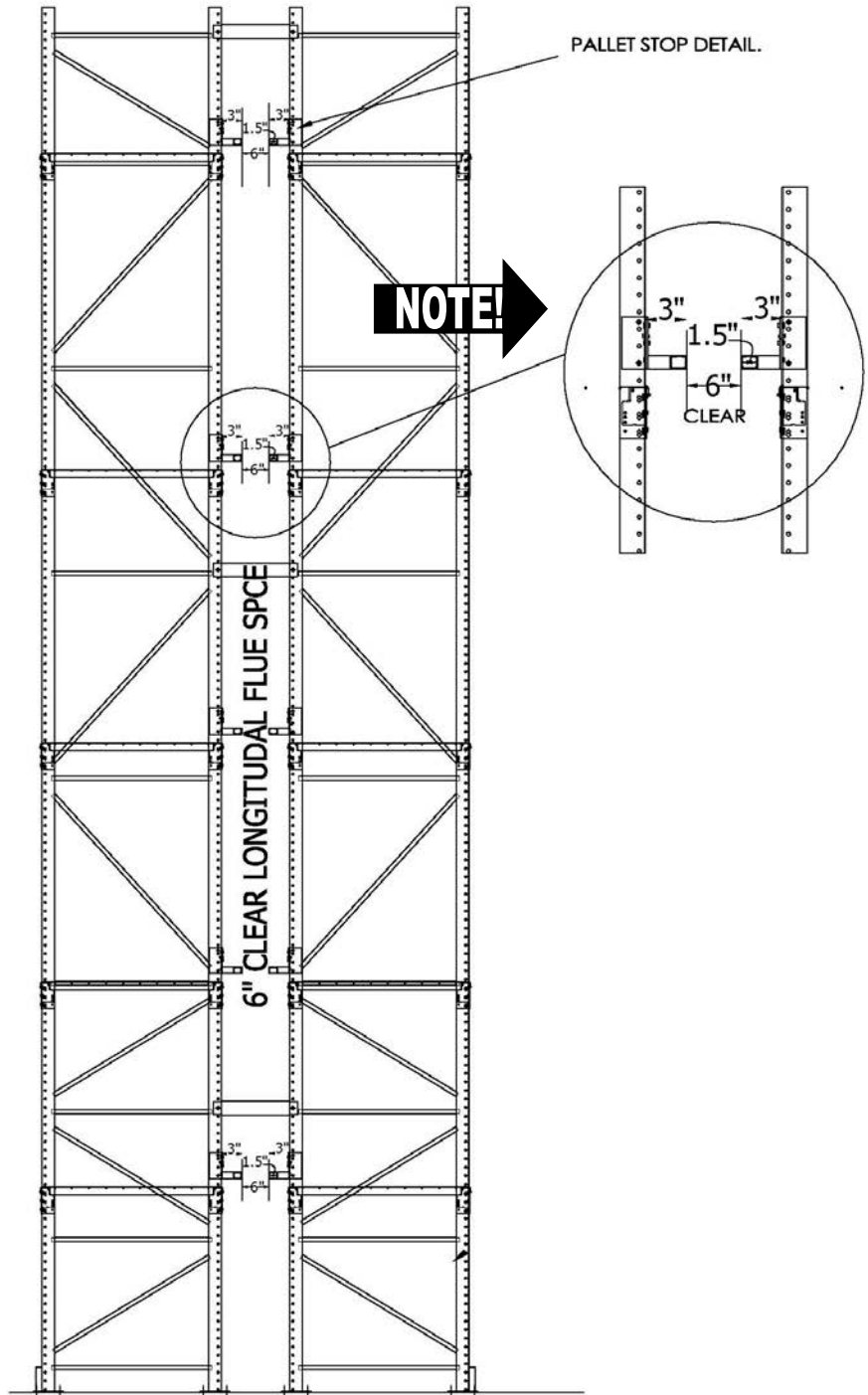

## ATTACHMENT 9

### High Pile Storage (HPS) Required Information

The following information shall be completed and copied onto the HPS plans for all projects within OFM jurisdiction:

Commodity Classification:

I  II  III  IV  High Hazard  Group A plastic

Commodity detailed

description: \_\_\_\_\_

\_\_\_\_\_

For Group A Plastics where the commodity classification is not High Hazard complete the following:

Expanded plastic: Percent by volume: \_\_\_\_%. Percent by weight: \_\_\_\_%

Non-expanded plastic: Percent by weight: \_\_\_\_%

Packaging consist of: \_\_\_\_\_

Cartoned  Free flowing  Non-expanding  Encapsulated  Non-encapsulated  
 Other \_\_\_\_\_

The maximum storage height (solid pile \_\_\_\_\_ rack \_\_\_\_\_)

The following storage methods are employed at this facility (mark all that apply):

Solid pile storage  Palletized  Single row rack  Double row rack  Multi-row rack  
 Other \_\_\_\_\_

Rack storage shelf:  N/A  Load beam only  Wire mesh  Wood slates  Plywood  
 Other (Describe) : \_\_\_\_\_

The area designated in the building and used for high piled storage is \_\_\_\_\_ square feet.

CLASS \_\_\_\_\_ commodity, \_\_\_\_\_ sq ft.

CLASS \_\_\_\_\_ commodity, \_\_\_\_\_ sq ft.

CLASS \_\_\_\_\_ commodity, \_\_\_\_\_ sq ft.

Smoke vents required  No  Yes Fusible link \_\_\_\_\_ degree F.

Draft Curtains Required?  Yes  NO

The overhead fire sprinkler system utilizes the following heads:

ESFR: K \_\_\_\_\_ at \_\_\_\_\_ PSI with \_\_\_\_\_ F° heads

Standard Coverage Heads: K \_\_\_\_\_  Pendant  Upright \_\_\_\_\_ degree with a density  
of \_\_\_\_\_ gpm over \_\_\_\_\_ square feet spaced at a maximum of \_\_\_\_\_ square feet per fire sprinkler.

NFPA 13 Design Table: \_\_\_\_\_ Curve: \_\_\_\_\_

Minimum distance between top of storage and sprinkler deflector: \_\_\_\_\_ Feet

In-rack sprinklers required  Yes  No

There is/are \_\_\_\_\_ level(s) of in-rack fire sprinkler protection.

Aisle width: \_\_\_\_\_ feet.

Fire access doors required?  Yes (Maximum distance of 100 lineal feet)  No

Flue spaces required?  Yes  No

Flue space between racks shall be maintained a minimum of:

Transverse \_\_\_\_\_" clear.  Must be vertically aligned (for storage >25')

Longitudinal \_\_\_\_\_" clear

Column protection required?  Yes  No

Pallet Stops Required?  Yes  No

Longitudinal pallet stop configuration:

Chain Link  Roll Form  "C" Channel  Other: \_\_\_\_\_

Transverse Flue Pallet Stop configuration:

Mechanical means (flue keepers, etc.)  Load beam markings "Keep Clear"

Hand Stack?  No  Yes # of tiers: \_\_\_\_\_ Chain link required  No  Yes