

PRELIMINARY HYDROLOGY REPORT

for

RAMONA & WEBSTER

Located in the City of Perris

County of Riverside

Prepared For:



3546 Concour St., Suite 100

Ontario, CA 91764

Tel: (909) 673-8727

Prepared by:



6879 Airport Drive

Riverside, CA 92504

Tel (951) 688-0241

Fax (951) 688-0599

Job No. 10331

April 6, 2023

May 17, 2023

Table of Contents

1. Purpose.....	1
2. Project Description	1
A. Vicinity Map.....	1
3. Pre-Development Hydrology/Hydraulic Conditions.....	1
4. Post-Development Hydrology/Hydraulic Conditions	2
5. Method of Analysis.....	2
6. Conclusion	2
Pre-Development 10 & 100 year (Rational Method).....	Section 1
Post-Development 10 & 100 year (Rational Method).....	Section 2
Inlet Calculations.....	Section 3
Riverside County Plates/Reference.....	Section 4

1. Purpose

The purpose of this study is to substantiate the hydrology design for Ramona Express and Webster Avenue. Adkan Engineers has prepared this study to ensure that adequate size and proper operation of drainage facilities are incorporated into the Post-Development project site.

2. Project Description

The Ramona & Webster Project is located at the southeast corner of Ramona Expressway and Webster Avenue. The site condition will propose a commercial/industrial warehouse (approximately 551,700 square-feet) on roughly 29.45 acres. The project proposes an impervious area of 1,103,768 sq. ft., which includes the roof and parking lot. The parking lot, drive aisle, and walkways are estimated to be 557,020 sq. feet. The pervious area is approximately 115,075 sq. ft. for the landscaping.

A. Vicinity Map

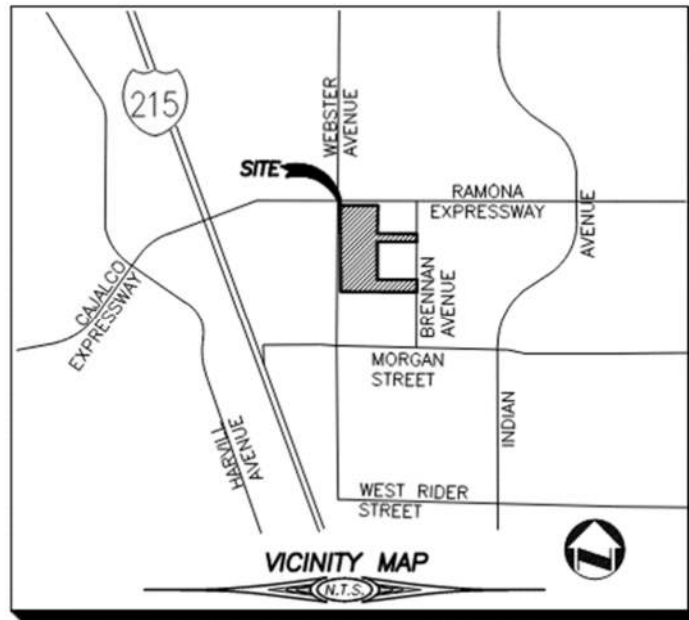

3. Pre-Development Hydrology

The existing land use is currently vacant and undeveloped with the exception for the southeast portion of the site that is occupied as an unpaved storage yard for the existing warehouse building. The storage yard will be cleared prior to grading. The existing topography slopes approximately 0.9% in a southwest to north east direction. Existing elevations range from approximately 1486 in the southwest corner to 1471 in the northeast corner (NAVD88). The existing drainage path is characterized by sheet flows that follow the existing topography.

Table 1	North Drainage Area	South Drainage Area
Q10 (cfs)	21.52	6.48
Q100 (cfs)	36.67	10.87
TC (min)	27.81	22.66
Acres	23.26	6.50

4. Post-Development Hydrology

The planned site condition will propose a commercial/industrial warehouse (approximately 551,700 square-feet) on roughly 29.45 acres. All on-site flows that will not be self-treated will be captured and treated before continuing to public facilities. The site proposes, 2 locations for underground chambers, 2 pumps, 2 filtera bioscapes, and 2 bioretention basin. The 2 bioretention basins will have overflow drainage structures. The Bioretention basin near the southwest corner of the proposed warehouse to treat the landscape area in that region. The northwest area of the project will be self-treating. The remaining bioretention basin will be treating the northern entrance of Brennan Avenue.

The initial bioretention basin location was at the north landscape area, however, there is an existing easement that was not indicated on the title report. Therefore, the bioretention basin had to be relocated. A reinforced concrete box (RCB) will replace the existing trapezoidal channel and match existing inverts along Ramona Expressway. The central area flows will be directed to catch basins with DrainPac filters that empty into proposed Contech CMP 96" non-perforated underground chambers that provides storage volume. The drop inlet DrainPac is designed for drop inlet type storm drains. They are installed in a self-supported configuration on the lip of the catch basin underneath the traffic grate. Once the chambers begin to fill, a proposed Jensen 348-S Series lift station will simultaneously force runoff into a Contech bioscape filterra system for treatment before being released into the public system. Similar underground chambers and bioscape filterra system will be applied to the southern part of the project except for a smaller lift station, Jensen 248-S Series.

The project will not be impacted by offsite flows. There will be drought tolerant landscape area at all self-treating locations and the trash enclosures which will be covered. The proposed project is within a HCOE exemption area. Proposed land use flowrates will not be required to match existing land use flowrates.

Table 2	North Drainage Area	South Drainage Area
Q10 (cfs)	34.75	8.80
Q100 (cfs)	55.24	13.93
TC (min)	12.98	11.61
Acres	21.68	5.35

5. Method of Analysis

The site hydrology was based upon Riverside County Flood Control and Water Conversation District Hydrology Manual, from which pertinent soil and rainfall information was obtained.

Storm flows were determined by the "RATIONAL METHOD HYDROLOGY COMPUTER PROGRAM", Riverside County Flood Control & Water Conservation District 1978 Hydrology Manual, produced by Bondamin Engineering.

6. Conclusion

The hydrologic calculations provided herein substantiate the design of the Post-Development project and indicate the following:

- Facilities will convey the 10 & 100 year storm events. Table 1 shows the pre-development and Table 2 shows the post-development peak flow rates for the 10-year and 100-year storm events.
- All inlets will provide emergency overflows in the event all inlets are plugged.

Therefore, it is our conclusion this project **does not** negatively impact the local community or watershed goals.

Section 1

Pre-Development 10 & 100 year Hydrology (Rational Method)

Riverside County Rational Hydrology Program

CIVILCADD/CIVILDESIGN Engineering Software,(c) 1989 - 2014 Version 9.0
Rational Hydrology Study Date: 03/08/23 File:ex10.out

***** Hydrology Study Control Information *****

English (in-lb) Units used in input data file

Program License Serial Number 5006

Rational Method Hydrology Program based on
Riverside County Flood Control & Water Conservation District
1978 hydrology manual

Storm event (year) = 10.00 Antecedent Moisture Condition = 2

2 year, 1 hour precipitation = 0.500(In.)
100 year, 1 hour precipitation = 1.300(In.)

Storm event year = 10.0
Calculated rainfall intensity data:
1 hour intensity = 0.829(In/Hr)
Slope of intensity duration curve = 0.5000

Process from Point/Station 1.000 to Point/Station 2.000
**** INITIAL AREA EVALUATION ****

Initial area flow distance = 1000.000(Ft.)
Top (of initial area) elevation = 1481.000(Ft.)
Bottom (of initial area) elevation = 1474.000(Ft.)
Difference in elevation = 7.000(Ft.)
Slope = 0.00700 s(percent)= 0.70
TC = $k(0.530)*[(length^3)/(elevation\ change)]^{0.2}$
Initial area time of concentration = 22.660 min.
Rainfall intensity = 1.349(In/Hr) for a 10.0 year storm
UNDEVELOPED (poor cover) subarea
Runoff Coefficient = 0.740
Decimal fraction soil group A = 0.000
Decimal fraction soil group B = 0.500
Decimal fraction soil group C = 0.500
Decimal fraction soil group D = 0.000
RI index for soil(AMC 2) = 82.00
Pervious area fraction = 1.000; Impervious fraction = 0.000
Initial subarea runoff = 6.486(CFS)
Total initial stream area = 6.500(Ac.)
Pervious area fraction = 1.000
End of computations, total study area = 6.50 (Ac.)
The following figures may
be used for a unit hydrograph study of the same area.

Area averaged pervious area fraction(Ap) = 1.000
Area averaged RI index number = 82.0

***** Hydrology Study Control Information *****
 English (in-lb) units used in input data file

 Program License Serial Number 5006

Rational Method Hydrology Program based on
 Riverside County Flood Control & Water Conservation District 1978 hydrology manual
 Storm event (year) = 10.00 Antecedent Moisture Condition = 2
 2 year, 1 hour precipitation = 0.500(In.)
 100 year, 1 hour precipitation = 1.300(In.)
 Storm event year = 10.0
 Calculated rainfall intensity data:
 1 hour intensity = 0.829(In/Hr)
 Slope of intensity duration curve = 0.5000

++++
 Process from Point/Station 3.000 to Point/Station 4.000
 **** INITIAL AREA EVALUATION ****

 Initial area flow distance = 967.000(Ft.)
 Top (of initial area) elevation = 1486.000(Ft.)
 Bottom (of initial area) elevation = 1476.500(Ft.)
 Difference in elevation = 9.500(Ft.)
 Slope = 0.00982 s(percent)= 0.98
 $TC = k(0.530)*[(length^3)/(elevation\ change)]^{0.2}$
 Initial area time of concentration = 20.892 min.
 Rainfall intensity = 1.405(In/Hr) for a 10.0 year storm
 UNDEVELOPED (poor cover) subarea
 Runoff coefficient = 0.745
 Decimal fraction soil group A = 0.000
 Decimal fraction soil group B = 0.500
 Decimal fraction soil group C = 0.500
 Decimal fraction soil group D = 0.000
 RI index for soil(AMC 2) = 82.00
 Pervious area fraction = 1.000; Impervious fraction = 0.000
 Initial subarea runoff = 8.100(CFS)
 Total initial stream area = 7.740(Ac.)
 Pervious area fraction = 1.000

++++
 Process from Point/Station 4.000 to Point/Station 5.000
 **** NATURAL CHANNEL TIME + SUBAREA FLOW ADDITION ****

 Top of natural channel elevation = 1476.500(Ft.)
 End of natural channel elevation = 1472.000(Ft.)
 Length of natural channel = 937.000(Ft.)
 Estimated mean flow rate at midpoint of channel = 16.222(CFS)
 Natural valley channel type used
 L.A. County flood control district formula for channel velocity:
 $Velocity(ft/s) = (7 + 8(q(English\ Units)^{.352})(slope^{0.5}))$
 Velocity using mean channel flow = 1.96(Ft/s)
 Correction to map slope used on extremely rugged channels with
 drops and waterfalls (Plate D-6.2)
 Normal channel slope = 0.0048
 Corrected/adjusted channel slope = 0.0048
 Travel time = 7.95 min. TC = 28.85 min.
 Adding area flow to channel
 UNDEVELOPED (poor cover) subarea
 Runoff coefficient = 0.723
 Decimal fraction soil group A = 0.000
 Decimal fraction soil group B = 0.500
 Decimal fraction soil group C = 0.500
 Decimal fraction soil group D = 0.000
 RI index for soil(AMC 2) = 82.00
 Pervious area fraction = 1.000; Impervious fraction = 0.000
 Rainfall intensity = 1.196(In/Hr) for a 10.0 year storm
 Subarea runoff = 13.418(CFS) for 15.520(Ac.)
 Total runoff = 21.519(CFS) Total area = 23.260(Ac.)
 End of computations, total study area = 23.26 (Ac.)
 The following figures maybe used for a unit hydrograph study of the same area.
 Area averaged pervious area fraction(Ap) = 1.000
 Area averaged RI index number = 82.0

Riverside County Rational Hydrology Program

CIVILCADD/CIVILDESIGN Engineering Software,(c) 1989 - 2014 Version 9.0
Rational Hydrology Study Date: 03/08/23 File:ex100.out

***** Hydrology Study Control Information *****

English (in-lb) Units used in input data file

Program License Serial Number 5006

Rational Method Hydrology Program based on
Riverside County Flood Control & Water Conservation District
1978 hydrology manual

Storm event (year) = 100.00 Antecedent Moisture Condition = 2

2 year, 1 hour precipitation = 0.500(In.)
100 year, 1 hour precipitation = 1.300(In.)

Storm event year = 100.0
Calculated rainfall intensity data:
1 hour intensity = 1.300(In/Hr)
Slope of intensity duration curve = 0.5000

Process from Point/Station 1.000 to Point/Station 2.000
**** INITIAL AREA EVALUATION ****

Initial area flow distance = 1000.000(Ft.)
Top (of initial area) elevation = 1481.000(Ft.)
Bottom (of initial area) elevation = 1474.000(Ft.)
Difference in elevation = 7.000(Ft.)
Slope = 0.00700 s(percent)= 0.70
TC = $k(0.530)*[(length^3)/(elevation\ change)]^{0.2}$
Initial area time of concentration = 22.660 min.
Rainfall intensity = 2.115(In/Hr) for a 100.0 year storm
UNDEVELOPED (poor cover) subarea
Runoff Coefficient = 0.791
Decimal fraction soil group A = 0.000
Decimal fraction soil group B = 0.500
Decimal fraction soil group C = 0.500
Decimal fraction soil group D = 0.000
RI index for soil(AMC 2) = 82.00
Pervious area fraction = 1.000; Impervious fraction = 0.000
Initial subarea runoff = 10.871(CFS)
Total initial stream area = 6.500(Ac.)
Pervious area fraction = 1.000
End of computations, total study area = 6.50 (Ac.)
The following figures may
be used for a unit hydrograph study of the same area.

Area averaged pervious area fraction(Ap) = 1.000
Area averaged RI index number = 82.0

***** Hydrology Study Control Information *****
English (in-lb) units used in input data file

Program License Serial Number 5006

Rational Method Hydrology Program based on
Riverside County Flood Control & Water Conservation District 1978 hydrology manual
Storm event (year) = 100.00 Antecedent Moisture Condition = 2
2 year, 1 hour precipitation = 0.500(In.)
100 year, 1 hour precipitation = 1.300(In.)
Storm event year = 100.0
Calculated rainfall intensity data:
1 hour intensity = 1.300(In/Hr)
Slope of intensity duration curve = 0.5000

++++
Process from Point/Station 3.000 to Point/Station 4.000
**** INITIAL AREA EVALUATION ****

Initial area flow distance = 967.000(Ft.)
Top (of initial area) elevation = 1486.000(Ft.)
Bottom (of initial area) elevation = 1476.500(Ft.)
Difference in elevation = 9.500(Ft.)
Slope = 0.00982 s(percent)= 0.98
TC = $k(0.530)*[(length^3)/(elevation\ change)]^{0.2}$
Initial area time of concentration = 20.892 min.
Rainfall intensity = 2.203(In/Hr) for a 100.0 year storm
UNDEVELOPED (poor cover) subarea
Runoff Coefficient = 0.794
Decimal fraction soil group A = 0.000
Decimal fraction soil group B = 0.500
Decimal fraction soil group C = 0.500
Decimal fraction soil group D = 0.000
RI index for soil(AMC 2) = 82.00
Pervious area fraction = 1.000; Impervious fraction = 0.000
Initial subarea runoff = 13.547(CFS)
Total initial stream area = 7.740(Ac.)
Pervious area fraction = 1.000

++++
Process from Point/Station 4.000 to Point/Station 5.000
**** NATURAL CHANNEL TIME + SUBAREA FLOW ADDITION ****

Top of natural channel elevation = 1476.500(Ft.)
End of natural channel elevation = 1472.000(Ft.)
Length of natural channel = 937.000(Ft.)
Estimated mean flow rate at midpoint of channel = 27.129(CFS)

Natural valley channel type used
L.A. County flood control district formula for channel velocity:
Velocity(ft/s) = $(7 + 8(q(\text{English Units})^{.352})(\text{slope}^{0.5}))$
Velocity using mean channel flow = 2.26(Ft/s)

Correction to map slope used on extremely rugged channels with
drops and waterfalls (Plate D-6.2)

Normal channel slope = 0.0048
Corrected/adjusted channel slope = 0.0048
Travel time = 6.92 min. TC = 27.81 min.

Adding area flow to channel
UNDEVELOPED (poor cover) subarea
Runoff Coefficient = 0.780
Decimal fraction soil group A = 0.000
Decimal fraction soil group B = 0.500
Decimal fraction soil group C = 0.500
Decimal fraction soil group D = 0.000
RI index for soil(AMC 2) = 82.00
Pervious area fraction = 1.000; Impervious fraction = 0.000
Rainfall intensity = 1.909(In/Hr) for a 100.0 year storm
Subarea runoff = 23.126(CFS) for 15.520(Ac.)
Total runoff = 36.673(CFS) Total area = 23.260(Ac.)
End of computations, total study area = 23.26 (Ac.)
The following figures maybe used for a unit hydrograph study of the same area.
Area averaged pervious area fraction(Ap) = 1.000
Area averaged RI index number = 82.0

PRE-DEVELOPMENT HYDROLOGY MAP RAMONA EXPRESS AND WEBSTER AVENUE

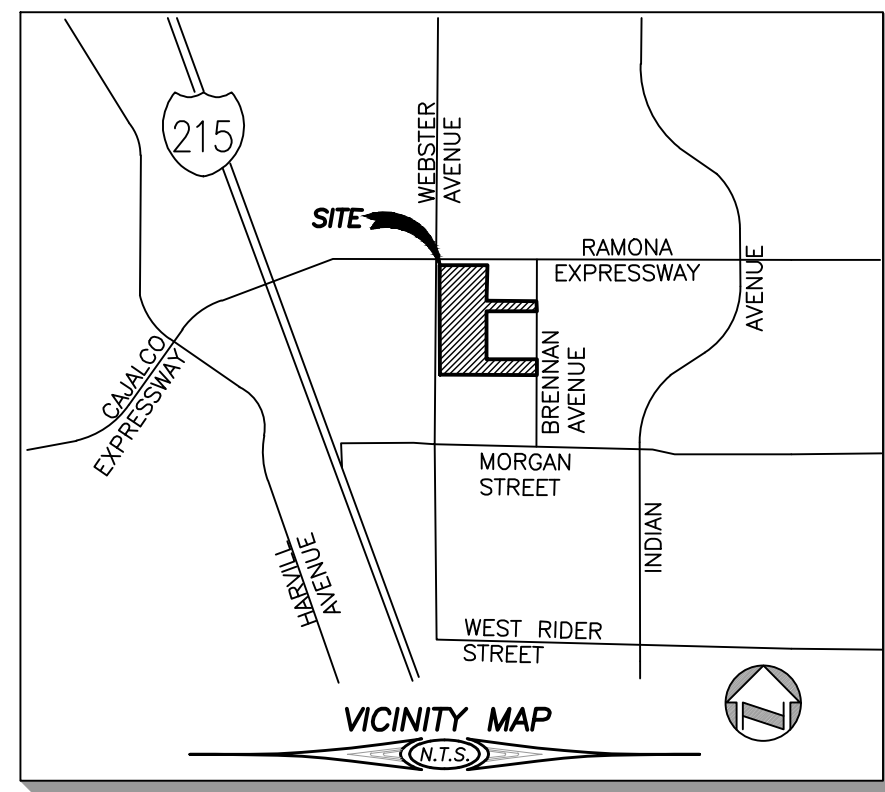

LEGEND

- DRAINAGE AREA BOUNDARY
- FLOW PATH
- FLOW ARROW

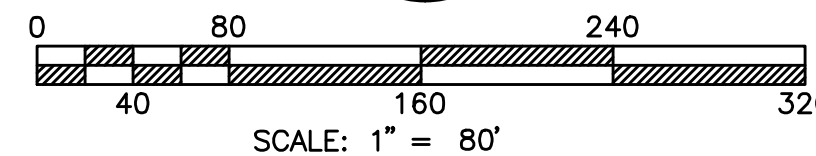
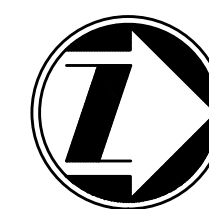
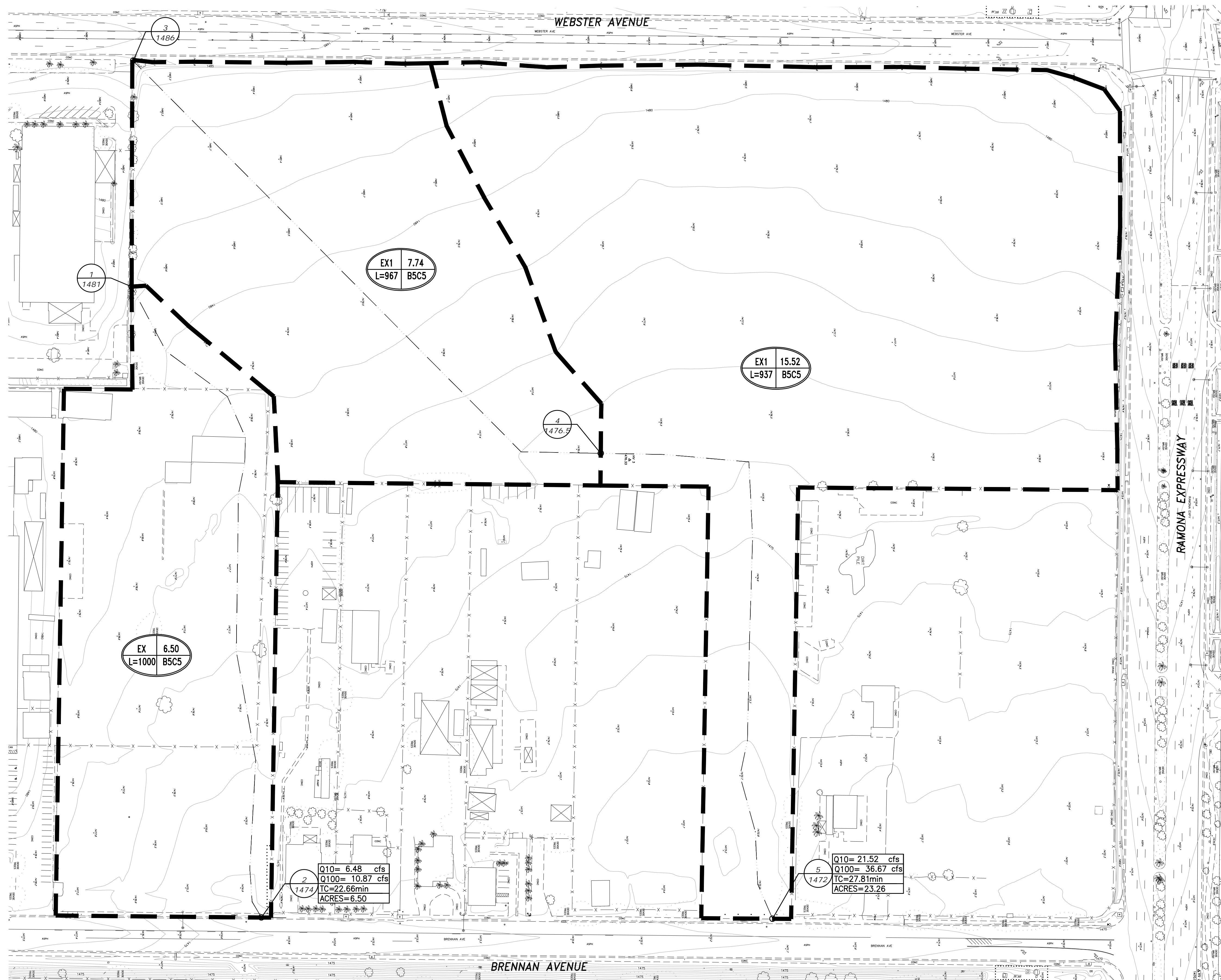

PRE DEVELOPMENT
HYDROLOGY MAP
PREPARATION DATE: MARCH 2023
REVISION DATE: MAY 2023
JOB NUMBER: 10331
PLANS PREPARED BY:

adkan
ENGINEERS
Civil Engineering • Surveying • Planning
6879 Airport Drive, Riverside, CA 92504
Tel: (951) 688-0241 • Fax: (951) 688-0599

Section 2

Post-Development 10 & 100 year Hydrology (Rational Method)

Riverside County Rational Hydrology Program

CIVILCADD/CIVILDESIGN Engineering Software,(c) 1989 - 2014 Version 9.0
Rational Hydrology Study Date: 04/06/23 File:PRO10.out

***** Hydrology Study Control Information *****

English (in-lb) Units used in input data file

Program License Serial Number 5006

Rational Method Hydrology Program based on
Riverside County Flood Control & Water Conservation District
1978 hydrology manual

Storm event (year) = 10.00 Antecedent Moisture Condition = 2

2 year, 1 hour precipitation = 0.500(In.)
100 year, 1 hour precipitation = 1.300(In.)

Storm event year = 10.0
Calculated rainfall intensity data:
1 hour intensity = 0.829(In/Hr)
Slope of intensity duration curve = 0.5000

Process from Point/Station 1.000 to Point/Station 2.000
**** INITIAL AREA EVALUATION ****

Initial area flow distance = 757.000(Ft.)
Top (of initial area) elevation = 1480.100(Ft.)
Bottom (of initial area) elevation = 1475.100(Ft.)
Difference in elevation = 5.000(Ft.)
Slope = 0.00661 s(percent)= 0.66
TC = $k(0.300)*[(length^3)/(elevation\ change)]^{0.2}$
Initial area time of concentration = 11.609 min.
Rainfall intensity = 1.885(In/Hr) for a 10.0 year storm
COMMERCIAL subarea type
Runoff Coefficient = 0.873
Decimal fraction soil group A = 0.000
Decimal fraction soil group B = 0.500
Decimal fraction soil group C = 0.500
Decimal fraction soil group D = 0.000
RI index for soil(AMC 2) = 62.50
Pervious area fraction = 0.100; Impervious fraction = 0.900
Initial subarea runoff = 8.806(CFS)
Total initial stream area = 5.350(Ac.)
Pervious area fraction = 0.100
End of computations, total study area = 5.35 (Ac.)
The following figures may
be used for a unit hydrograph study of the same area.

Area averaged pervious area fraction(Ap) = 0.100
Area averaged RI index number = 62.5

Riverside County Rational Hydrology Program

CIVILCADD/CIVILDESIGN Engineering Software,(c) 1989 - 2014 Version 9.0
Rational Hydrology Study Date: 04/06/23 File:PRO110.out

***** Hydrology Study Control Information *****

English (in-lb) Units used in input data file

Program License Serial Number 5006

Rational Method Hydrology Program based on
Riverside County Flood Control & Water Conservation District
1978 hydrology manual

Storm event (year) = 10.00 Antecedent Moisture Condition = 2

2 year, 1 hour precipitation = 0.500(In.)
100 year, 1 hour precipitation = 1.300(In.)

Storm event year = 10.0
Calculated rainfall intensity data:
1 hour intensity = 0.829(In/Hr)
Slope of intensity duration curve = 0.5000

Process from Point/Station 3.000 to Point/Station 4.000
**** INITIAL AREA EVALUATION ****

Initial area flow distance = 498.000(Ft.)
Top (of initial area) elevation = 1486.200(Ft.)
Bottom (of initial area) elevation = 1479.510(Ft.)
Difference in elevation = 6.690(Ft.)
Slope = 0.01343 s(percent)= 1.34
TC = $k(0.300)*[(length^3)/(elevation\ change)]^{0.2}$
Initial area time of concentration = 8.519 min.
Rainfall intensity = 2.200(In/Hr) for a 10.0 year storm
COMMERCIAL subarea type
Runoff Coefficient = 0.876
Decimal fraction soil group A = 0.000
Decimal fraction soil group B = 0.500
Decimal fraction soil group C = 0.500
Decimal fraction soil group D = 0.000
RI index for soil(AMC 2) = 62.50
Pervious area fraction = 0.100; Impervious fraction = 0.900
Initial subarea runoff = 4.202(CFS)
Total initial stream area = 2.180(Ac.)
Pervious area fraction = 0.100

Process from Point/Station 4.000 to Point/Station 4.500
**** PIPEFLOW TRAVEL TIME (Program estimated size) ****

Upstream point/station elevation = 1479.510(Ft.)
Downstream point/station elevation = 1475.600(Ft.)
Pipe length = 913.00(Ft.) Manning's N = 0.013
No. of pipes = 1 Required pipe flow = 4.202(CFS)
Nearest computed pipe diameter = 15.00(In.)
Calculated individual pipe flow = 4.202(CFS)
Normal flow depth in pipe = 12.21(In.)
Flow top width inside pipe = 11.67(In.)
Critical Depth = 9.96(In.)
Pipe flow velocity = 3.93(Ft/s)
Travel time through pipe = 3.87 min.
Time of concentration (TC) = 12.39 min.

Process from Point/Station 4.500 to Point/Station 4.500
**** CONFLUENCE OF MINOR STREAMS ****

Along Main Stream number: 1 in normal stream number 1
Stream flow area = 2.180(Ac.)
Runoff from this stream = 4.202(CFS)
Time of concentration = 12.39 min.
Rainfall intensity = 1.824(In/Hr)

Process from Point/Station 4.250 to Point/Station 4.500
 **** INITIAL AREA EVALUATION ****

Initial area flow distance = 736.000(Ft.)
 Top (of initial area) elevation = 1480.000(Ft.)
 Bottom (of initial area) elevation = 1475.600(Ft.)
 Difference in elevation = 4.400(Ft.)
 Slope = 0.00598 s(percent)= 0.60
 $TC = k(0.300)*[(length^3)/(elevation\ change)]^{0.2}$
 Initial area time of concentration = 11.710 min.
 Rainfall intensity = 1.877(In/Hr) for a 10.0 year storm
 COMMERCIAL subarea type
 Runoff Coefficient = 0.873
 Decimal fraction soil group A = 0.000
 Decimal fraction soil group B = 0.500
 Decimal fraction soil group C = 0.500
 Decimal fraction soil group D = 0.000
 RI index for soil(AMC 2) = 62.50
 Pervious area fraction = 0.100; Impervious fraction = 0.900
 Initial subarea runoff = 15.551(CFS)
 Total initial stream area = 9.490(Ac.)
 Pervious area fraction = 0.100

Process from Point/Station 4.500 to Point/Station 4.500
 **** CONFLUENCE OF MINOR STREAMS ****

Along Main Stream number: 1 in normal stream number 2
 Stream flow area = 9.490(Ac.)
 Runoff from this stream = 15.551(CFS)
 Time of concentration = 11.71 min.
 Rainfall intensity = 1.877(In/Hr)
 Summary of stream data:

Stream No.	Flow rate (CFS)	TC (min)	Rainfall Intensity (In/Hr)
------------	-----------------	----------	----------------------------

1	4.202	12.39	1.824
2	15.551	11.71	1.877

Largest stream flow has longer or shorter time of concentration

Qp = 15.551 + sum of
 $Qa \cdot Tb/Ta$
 $4.202 * 0.945 = 3.970$
 Qp = 19.521

Total of 2 streams to confluence:
 Flow rates before confluence point:
 4.202 15.551
 Area of streams before confluence:
 2.180 9.490
 Results of confluence:
 Total flow rate = 19.521(CFS)
 Time of concentration = 11.710 min.
 Effective stream area after confluence = 11.670(Ac.)

Process from Point/Station 4.500 to Point/Station 6.000
 **** PIPEFLOW TRAVEL TIME (Program estimated size) ****

Upstream point/station elevation = 1475.600(Ft.)
 Downstream point/station elevation = 1469.000(Ft.)
 Pipe length = 350.00(Ft.) Manning's N = 0.013
 No. of pipes = 1 Required pipe flow = 19.521(CFS)
 Nearest computed pipe diameter = 21.00(In.)
 Calculated individual pipe flow = 19.521(CFS)
 Normal flow depth in pipe = 15.54(In.)
 Flow top width inside pipe = 18.42(In.)
 Critical Depth = 19.05(In.)
 Pipe flow velocity = 10.23(Ft/s)
 Travel time through pipe = 0.57 min.
 Time of concentration (TC) = 12.28 min.

Process from Point/Station 6.000 to Point/Station 6.000
 **** CONFLUENCE OF MAIN STREAMS ****

The following data inside Main Stream is listed:
 In Main Stream number: 1
 Stream flow area = 11.670(Ac.)

Runoff from this stream = 19.521(CFS)
Time of concentration = 12.28 min.
Rainfall intensity = 1.833(In/Hr)
Program is now starting with Main Stream No. 2

Process from Point/Station 7.000 to Point/Station 8.000
**** INITIAL AREA EVALUATION ****

Initial area flow distance = 469.000(Ft.)
Top (of initial area) elevation = 1483.100(Ft.)
Bottom (of initial area) elevation = 1477.700(Ft.)
Difference in elevation = 5.400(Ft.)
Slope = 0.01151 s(percent)= 1.15
TC = $k(0.300)*[(\text{length}^3)/(\text{elevation change})]^{0.2}$
Initial area time of concentration = 8.577 min.
Rainfall intensity = 2.193(In/Hr) for a 10.0 year storm
COMMERCIAL subarea type
Runoff Coefficient = 0.876
Decimal fraction soil group A = 0.000
Decimal fraction soil group B = 0.500
Decimal fraction soil group C = 0.500
Decimal fraction soil group D = 0.000
RI index for soil(AMC 2) = 62.50
Pervious area fraction = 0.100; Impervious fraction = 0.900
Initial subarea runoff = 5.839(CFS)
Total initial stream area = 3.040(Ac.)
Pervious area fraction = 0.100

Process from Point/Station 8.000 to Point/Station 9.000
**** PIPEFLOW TRAVEL TIME (Program estimated size) ****

Upstream point/station elevation = 1477.700(Ft.)
Downstream point/station elevation = 1475.900(Ft.)
Pipe length = 299.00(Ft.) Manning's N = 0.013
No. of pipes = 1 Required pipe flow = 5.839(CFS)
Nearest computed pipe diameter = 18.00(In.)
Calculated individual pipe flow = 5.839(CFS)
Normal flow depth in pipe = 11.27(In.)
Flow top width inside pipe = 17.42(In.)
Critical Depth = 11.19(In.)
Pipe flow velocity = 5.01(Ft/s)
Travel time through pipe = 0.99 min.
Time of concentration (TC) = 9.57 min.

Process from Point/Station 9.000 to Point/Station 9.000
**** CONFLUENCE OF MINOR STREAMS ****

Along Main Stream number: 2 in normal stream number 1
Stream flow area = 3.040(Ac.)
Runoff from this stream = 5.839(CFS)
Time of concentration = 9.57 min.
Rainfall intensity = 2.076(In/Hr)

Process from Point/Station 8.500 to Point/Station 9.000
**** INITIAL AREA EVALUATION ****

Initial area flow distance = 360.000(Ft.)
Top (of initial area) elevation = 1480.000(Ft.)
Bottom (of initial area) elevation = 1475.900(Ft.)
Difference in elevation = 4.100(Ft.)
Slope = 0.01139 s(percent)= 1.14
TC = $k(0.300)*[(\text{length}^3)/(\text{elevation change})]^{0.2}$
Initial area time of concentration = 7.733 min.
Rainfall intensity = 2.310(In/Hr) for a 10.0 year storm
COMMERCIAL subarea type
Runoff Coefficient = 0.877
Decimal fraction soil group A = 0.000
Decimal fraction soil group B = 0.500
Decimal fraction soil group C = 0.500
Decimal fraction soil group D = 0.000
RI index for soil(AMC 2) = 62.50
Pervious area fraction = 0.100; Impervious fraction = 0.900
Initial subarea runoff = 6.703(CFS)
Total initial stream area = 3.310(Ac.)
Pervious area fraction = 0.100

Process from Point/Station 9.000 to Point/Station 9.000
**** CONFLUENCE OF MINOR STREAMS ****

Along Main Stream number: 2 in normal stream number 2
Stream flow area = 3.310(Ac.)
Runoff from this stream = 6.703(CFS)
Time of concentration = 7.73 min.
Rainfall intensity = 2.310(In/Hr)
Summary of stream data:

Stream No.	Flow rate (CFS)	TC (min)	Rainfall Intensity (In/Hr)
------------	-----------------	----------	----------------------------

1	5.839	9.57	2.076
2	6.703	7.73	2.310

Largest stream flow has longer or shorter time of concentration

Qp = 6.703 + sum of
Qa Tb/Ta
5.839 * 0.808 = 4.718
Qp = 11.421

Total of 2 streams to confluence:
Flow rates before confluence point:
5.839 6.703

Area of streams before confluence:
3.040 3.310

Results of confluence:
Total flow rate = 11.421(CFS)
Time of concentration = 7.733 min.
Effective stream area after confluence = 6.350(Ac.)

Process from Point/Station 9.000 to Point/Station 6.000
**** PIPEFLOW TRAVEL TIME (Program estimated size) ****

Upstream point/station elevation = 1475.200(Ft.)
Downstream point/station elevation = 1469.000(Ft.)
Pipe length = 279.00(Ft.) Manning's N = 0.013
No. of pipes = 1 Required pipe flow = 11.421(CFS)
Nearest computed pipe diameter = 18.00(In.)
Calculated individual pipe flow = 11.421(CFS)
Normal flow depth in pipe = 11.41(In.)
Flow top width inside pipe = 17.34(In.)
Critical Depth = 15.48(In.)
Pipe flow velocity = 9.67(Ft/s)
Travel time through pipe = 0.48 min.
Time of concentration (TC) = 8.21 min.

Process from Point/Station 6.000 to Point/Station 6.000
**** CONFLUENCE OF MAIN STREAMS ****

The following data inside Main Stream is listed:

In Main Stream number: 2
Stream flow area = 6.350(Ac.)
Runoff from this stream = 11.421(CFS)
Time of concentration = 8.21 min.
Rainfall intensity = 2.241(In/Hr)
Program is now starting with Main Stream No. 3

Process from Point/Station 4.750 to Point/Station 5.000
**** INITIAL AREA EVALUATION ****

Initial area flow distance = 472.000(Ft.)
Top (of initial area) elevation = 1480.000(Ft.)
Bottom (of initial area) elevation = 1474.000(Ft.)
Difference in elevation = 6.000(Ft.)
Slope = 0.01271 s(percent) = 1.27
TC = $k(0.300)*[(length^3)/(elevation\ change)]^{0.2}$
Initial area time of concentration = 8.431 min.
Rainfall intensity = 2.212(In/Hr) for a 10.0 year storm
COMMERCIAL subarea type
Runoff Coefficient = 0.876
Decimal fraction soil group A = 0.000
Decimal fraction soil group B = 0.500
Decimal fraction soil group C = 0.500
Decimal fraction soil group D = 0.000
RI index for soil(AMC 2) = 62.50
Pervious area fraction = 0.100; Impervious fraction = 0.900
Initial subarea runoff = 5.426(CFS)
Total initial stream area = 2.800(Ac.)

Pervious area fraction = 0.100

Process from Point/Station 5.000 to Point/Station 6.000
**** PIPEFLOW TRAVEL TIME (Program estimated size) ****

Upstream point/station elevation = 1474.000(Ft.)
Downstream point/station elevation = 1469.000(Ft.)
Pipe length = 77.00(Ft.) Manning's N = 0.013
No. of pipes = 1 Required pipe flow = 5.426(CFS)
Nearest computed pipe diameter = 12.00(In.)
Calculated individual pipe flow = 5.426(CFS)
Normal flow depth in pipe = 6.68(In.)
Flow top width inside pipe = 11.92(In.)
Critical Depth = 11.24(In.)
Pipe flow velocity = 12.07(Ft/s)
Travel time through pipe = 0.11 min.
Time of concentration (TC) = 8.54 min.

Process from Point/Station 6.000 to Point/Station 6.000
**** CONFLUENCE OF MAIN STREAMS ****

The following data inside Main Stream is listed:

In Main Stream number: 3
Stream flow area = 2.800(Ac.)
Runoff from this stream = 5.426(CFS)
Time of concentration = 8.54 min.
Rainfall intensity = 2.198(In/Hr)
Summary of stream data:

Stream No.	Flow rate (CFS)	TC (min)	Rainfall Intensity (In/Hr)
1	19.521	12.28	1.833
2	11.421	8.21	2.241
3	5.426	8.54	2.198

Largest stream flow has longer time of concentration

Qp = 19.521 + sum of
Qb Ia/Ib
11.421 * 0.818 = 9.341
Qb Ia/Ib
5.426 * 0.834 = 4.524
Qp = 33.386

Total of 3 main streams to confluence:

Flow rates before confluence point:
19.521 11.421 5.426
Area of streams before confluence:
11.670 6.350 2.800

Results of confluence:

Total flow rate = 33.386(CFS)
Time of concentration = 12.280 min.
Effective stream area after confluence = 20.820(Ac.)

Process from Point/Station 6.000 to Point/Station 10.000
**** PIPEFLOW TRAVEL TIME (Program estimated size) ****

Upstream point/station elevation = 1469.000(Ft.)
Downstream point/station elevation = 1467.000(Ft.)
Pipe length = 358.00(Ft.) Manning's N = 0.013
No. of pipes = 1 Required pipe flow = 33.386(CFS)
Nearest computed pipe diameter = 33.00(In.)
Calculated individual pipe flow = 33.386(CFS)
Normal flow depth in pipe = 23.25(In.)
Flow top width inside pipe = 30.11(In.)
Critical Depth = 23.07(In.)
Pipe flow velocity = 7.46(Ft/s)
Travel time through pipe = 0.80 min.
Time of concentration (TC) = 13.08 min.

Process from Point/Station 10.000 to Point/Station 10.000
**** CONFLUENCE OF MINOR STREAMS ****

Along Main Stream number: 1 in normal stream number 1
Stream flow area = 20.820(Ac.)
Runoff from this stream = 33.386(CFS)

Time of concentration = 13.08 min.
 Rainfall intensity = 1.776(In/Hr)

 Process from Point/Station 11.000 to Point/Station 12.000
 **** INITIAL AREA EVALUATION ****

Initial area flow distance = 197.000(Ft.)
 Top (of initial area) elevation = 1475.400(Ft.)
 Bottom (of initial area) elevation = 1471.200(Ft.)
 Difference in elevation = 4.200(Ft.)
 Slope = 0.02132 s(percent)= 2.13
 $TC = k(0.300)*[(length^3)/(elevation\ change)]^{0.2}$
 Initial area time of concentration = 5.360 min.
 Rainfall intensity = 2.774(In/Hr) for a 10.0 year storm
 COMMERCIAL subarea type
 Runoff Coefficient = 0.880
 Decimal fraction soil group A = 0.000
 Decimal fraction soil group B = 0.500
 Decimal fraction soil group C = 0.500
 Decimal fraction soil group D = 0.000
 RI index for soil(AMC 2) = 62.50
 Pervious area fraction = 0.100; Impervious fraction = 0.900
 Initial subarea runoff = 2.099(CFS)
 Total initial stream area = 0.860(Ac.)
 Pervious area fraction = 0.100

 Process from Point/Station 12.000 to Point/Station 10.000
 **** PIPEFLOW TRAVEL TIME (Program estimated size) ****

Upstream point/station elevation = 1471.200(Ft.)
 Downstream point/station elevation = 1467.000(Ft.)
 Pipe length = 93.00(Ft.) Manning's N = 0.013
 No. of pipes = 1 Required pipe flow = 2.099(CFS)
 Nearest computed pipe diameter = 9.00(In.)
 Calculated individual pipe flow = 2.099(CFS)
 Normal flow depth in pipe = 5.01(In.)
 Flow top width inside pipe = 8.94(In.)
 Critical Depth = 7.85(In.)
 Pipe flow velocity = 8.31(Ft/s)
 Travel time through pipe = 0.19 min.
 Time of concentration (TC) = 5.55 min.

 Process from Point/Station 10.000 to Point/Station 10.000
 **** CONFLUENCE OF MINOR STREAMS ****

Along Main Stream number: 1 in normal stream number 2
 Stream flow area = 0.860(Ac.)
 Runoff from this stream = 2.099(CFS)
 Time of concentration = 5.55 min.
 Rainfall intensity = 2.727(In/Hr)
 Summary of stream data:

Stream No.	Flow rate (CFS)	TC (min)	Rainfall Intensity (In/Hr)
------------	-----------------	----------	----------------------------

1	33.386	13.08	1.776
2	2.099	5.55	2.727

Largest stream flow has longer time of concentration

Qp = 33.386 + sum of
 $Q_b \cdot \frac{I_a}{I_b}$
 $2.099 * 0.651 = 1.367$
 Qp = 34.753

Total of 2 streams to confluence:

Flow rates before confluence point:
 33.386 2.099

Area of streams before confluence:
 20.820 0.860

Results of confluence:

Total flow rate = 34.753(CFS)
 Time of concentration = 13.080 min.
 Effective stream area after confluence = 21.680(Ac.)
 End of computations, total study area = 21.68 (Ac.)

The following figures maybe used for a unit hydrograph study of the same area.
 Area averaged pervious area fraction(Ap) = 0.100
 Area averaged RI index number = 62.5

Riverside County Rational Hydrology Program

CIVILCADD/CIVILDESIGN Engineering Software,(c) 1989 - 2014 Version 9.0
Rational Hydrology Study Date: 04/06/23 File:PRO210.out

***** Hydrology Study Control Information *****

English (in-lb) Units used in input data file

Program License Serial Number 5006

Rational Method Hydrology Program based on
Riverside County Flood Control & Water Conservation District
1978 hydrology manual

Storm event (year) = 10.00 Antecedent Moisture Condition = 2

2 year, 1 hour precipitation = 0.500(In.)
100 year, 1 hour precipitation = 1.300(In.)

Storm event year = 10.0
Calculated rainfall intensity data:
1 hour intensity = 0.829(In/Hr)
Slope of intensity duration curve = 0.5000

+++++
Process from Point/Station 13.000 to Point/Station 14.000
**** INITIAL AREA EVALUATION ****

Initial area flow distance = 287.000(Ft.)
Top (of initial area) elevation = 1485.000(Ft.)
Bottom (of initial area) elevation = 1482.000(Ft.)
Difference in elevation = 3.000(Ft.)
Slope = 0.01045 s(percent)= 1.05
TC = $k(0.940)*[(length^3)/(elevation\ change)]^{0.2}$
Initial area time of concentration = 22.513 min.
Rainfall intensity = 1.354(In/Hr) for a 10.0 year storm
UNDEVELOPED (good cover) subarea
Runoff coefficient = 0.610
Decimal fraction soil group A = 0.000
Decimal fraction soil group B = 0.500
Decimal fraction soil group C = 0.500
Decimal fraction soil group D = 0.000
RI index for soil(AMC 2) = 67.50
Pervious area fraction = 1.000; Impervious fraction = 0.000
Initial subarea runoff = 0.537(CFS)
Total initial stream area = 0.650(Ac.)
Pervious area fraction = 1.000
End of computations, total study area = 0.65 (Ac.)
The following figures may
be used for a unit hydrograph study of the same area.

Area averaged pervious area fraction(Ap) = 1.000
Area averaged RI index number = 67.5

Riverside County Rational Hydrology Program

CIVILCADD/CIVILDESIGN Engineering Software,(c) 1989 - 2014 Version 9.0
Rational Hydrology Study Date: 04/06/23 File:PRO100.out

***** Hydrology Study Control Information *****

English (in-lb) Units used in input data file

Program License Serial Number 5006

Rational Method Hydrology Program based on
Riverside County Flood Control & Water Conservation District
1978 hydrology manual

Storm event (year) = 100.00 Antecedent Moisture Condition = 2

2 year, 1 hour precipitation = 0.500(In.)
100 year, 1 hour precipitation = 1.300(In.)

Storm event year = 100.0
Calculated rainfall intensity data:
1 hour intensity = 1.300(In/Hr)
Slope of intensity duration curve = 0.5000

Process from Point/Station 1.000 to Point/Station 2.000
**** INITIAL AREA EVALUATION ****

Initial area flow distance = 757.000(Ft.)
Top (of initial area) elevation = 1480.100(Ft.)
Bottom (of initial area) elevation = 1475.100(Ft.)
Difference in elevation = 5.000(Ft.)
Slope = 0.00661 s(percent)= 0.66
TC = $k(0.300)*[(length^3)/(elevation\ change)]^{0.2}$
Initial area time of concentration = 11.609 min.
Rainfall intensity = 2.955(In/Hr) for a 100.0 year storm
COMMERCIAL subarea type
Runoff Coefficient = 0.881
Decimal fraction soil group A = 0.000
Decimal fraction soil group B = 0.500
Decimal fraction soil group C = 0.500
Decimal fraction soil group D = 0.000
RI index for soil(AMC 2) = 62.50
Pervious area fraction = 0.100; Impervious fraction = 0.900
Initial subarea runoff = 13.927(CFS)
Total initial stream area = 5.350(Ac.)
Pervious area fraction = 0.100
End of computations, total study area = 5.35 (Ac.)
The following figures may
be used for a unit hydrograph study of the same area.

Area averaged pervious area fraction(Ap) = 0.100
Area averaged RI index number = 62.5

Riverside County Rational Hydrology Program

CIVILCADD/CIVILDESIGN Engineering Software,(c) 1989 - 2014 Version 9.0
Rational Hydrology Study Date: 04/06/23 File:PRO1100.out

***** Hydrology Study Control Information *****

English (in-lb) Units used in input data file

Program License Serial Number 5006

Rational Method Hydrology Program based on
Riverside County Flood Control & Water Conservation District
1978 hydrology manual

Storm event (year) = 100.00 Antecedent Moisture Condition = 2

2 year, 1 hour precipitation = 0.500(In.)
100 year, 1 hour precipitation = 1.300(In.)

Storm event year = 100.0
Calculated rainfall intensity data:
1 hour intensity = 1.300(In/Hr)
Slope of intensity duration curve = 0.5000

Process from Point/Station 3.000 to Point/Station 4.000
**** INITIAL AREA EVALUATION ****

Initial area flow distance = 498.000(Ft.)
Top (of initial area) elevation = 1486.200(Ft.)
Bottom (of initial area) elevation = 1479.510(Ft.)
Difference in elevation = 6.690(Ft.)
Slope = 0.01343 s(percent)= 1.34
TC = $k(0.300)*[(length^3)/(elevation\ change)]^{0.2}$
Initial area time of concentration = 8.519 min.
Rainfall intensity = 3.450(In/Hr) for a 100.0 year storm
COMMERCIAL subarea type
Runoff Coefficient = 0.883
Decimal fraction soil group A = 0.000
Decimal fraction soil group B = 0.500
Decimal fraction soil group C = 0.500
Decimal fraction soil group D = 0.000
RI index for soil(AMC 2) = 62.50
Pervious area fraction = 0.100; Impervious fraction = 0.900
Initial subarea runoff = 6.642(CFS)
Total initial stream area = 2.180(Ac.)
Pervious area fraction = 0.100

Process from Point/Station 4.000 to Point/Station 4.500
**** PIPEFLOW TRAVEL TIME (Program estimated size) ****

Upstream point/station elevation = 1479.510(Ft.)
Downstream point/station elevation = 1475.600(Ft.)
Pipe length = 913.00(Ft.) Manning's N = 0.013
No. of pipes = 1 Required pipe flow = 6.642(CFS)
Nearest computed pipe diameter = 18.00(In.)
Calculated individual pipe flow = 6.642(CFS)
Normal flow depth in pipe = 14.23(In.)
Flow top width inside pipe = 14.65(In.)
Critical Depth = 11.97(In.)
Pipe flow velocity = 4.43(Ft/s)
Travel time through pipe = 3.43 min.
Time of concentration (TC) = 11.95 min.

Process from Point/Station 4.500 to Point/Station 4.500
**** CONFLUENCE OF MINOR STREAMS ****

Along Main Stream number: 1 in normal stream number 1
Stream flow area = 2.180(Ac.)
Runoff from this stream = 6.642(CFS)
Time of concentration = 11.95 min.
Rainfall intensity = 2.913(In/Hr)

+++++
 Process from Point/Station 4.250 to Point/Station 4.500
 **** INITIAL AREA EVALUATION ****

Initial area flow distance = 736.000(Ft.)
 Top (of initial area) elevation = 1480.000(Ft.)
 Bottom (of initial area) elevation = 1475.600(Ft.)
 Difference in elevation = 4.400(Ft.)
 Slope = 0.00598 s(percent)= 0.60
 $TC = k(0.300)*[(length^3)/(elevation\ change)]^{0.2}$
 Initial area time of concentration = 11.710 min.
 Rainfall intensity = 2.943(In/Hr) for a 100.0 year storm
 COMMERCIAL subarea type
 Runoff Coefficient = 0.881
 Decimal fraction soil group A = 0.000
 Decimal fraction soil group B = 0.500
 Decimal fraction soil group C = 0.500
 Decimal fraction soil group D = 0.000
 RI index for soil(AMC 2) = 62.50
 Pervious area fraction = 0.100; Impervious fraction = 0.900
 Initial subarea runoff = 24.596(CFS)
 Total initial stream area = 9.490(Ac.)
 Pervious area fraction = 0.100

+++++
 Process from Point/Station 4.500 to Point/Station 4.500
 **** CONFLUENCE OF MINOR STREAMS ****

Along Main Stream number: 1 in normal stream number 2
 Stream flow area = 9.490(Ac.)
 Runoff from this stream = 24.596(CFS)
 Time of concentration = 11.71 min.
 Rainfall intensity = 2.943(In/Hr)
 Summary of stream data:

Stream No.	Flow rate (CFS)	TC (min)	Rainfall Intensity (In/Hr)
------------	-----------------	----------	----------------------------

1	6.642	11.95	2.913
2	24.596	11.71	2.943

Largest stream flow has longer or shorter time of concentration

Qp = 24.596 + sum of
 $Qa \cdot Tb/Ta$
 $6.642 * 0.980 = 6.507$
 Qp = 31.103

Total of 2 streams to confluence:
 Flow rates before confluence point:
 6.642 24.596
 Area of streams before confluence:
 2.180 9.490
 Results of confluence:
 Total flow rate = 31.103(CFS)
 Time of concentration = 11.710 min.
 Effective stream area after confluence = 11.670(Ac.)

+++++
 Process from Point/Station 4.500 to Point/Station 6.000
 **** PIPEFLOW TRAVEL TIME (Program estimated size) ****

Upstream point/station elevation = 1475.600(Ft.)
 Downstream point/station elevation = 1469.000(Ft.)
 Pipe length = 350.00(Ft.) Manning's N = 0.013
 No. of pipes = 1 Required pipe flow = 31.103(CFS)
 Nearest computed pipe diameter = 24.00(In.)
 Calculated individual pipe flow = 31.103(CFS)
 Normal flow depth in pipe = 19.69(In.)
 Flow top width inside pipe = 18.43(In.)
 Critical Depth = 22.54(In.)
 Pipe flow velocity = 11.27(Ft/s)
 Travel time through pipe = 0.52 min.
 Time of concentration (TC) = 12.23 min.

+++++
 Process from Point/Station 6.000 to Point/Station 6.000
 **** CONFLUENCE OF MAIN STREAMS ****

The following data inside Main Stream is listed:
 In Main Stream number: 1
 Stream flow area = 11.670(Ac.)

Runoff from this stream = 31.103(CFS)
Time of concentration = 12.23 min.
Rainfall intensity = 2.880(In/Hr)
Program is now starting with Main Stream No. 2

Process from Point/Station 7.000 to Point/Station 8.000
**** INITIAL AREA EVALUATION ****

Initial area flow distance = 469.000(Ft.)
Top (of initial area) elevation = 1483.100(Ft.)
Bottom (of initial area) elevation = 1477.700(Ft.)
Difference in elevation = 5.400(Ft.)
Slope = 0.01151 s(percent)= 1.15
TC = $k(0.300)*[(length^3)/(elevation\ change)]^{0.2}$
Initial area time of concentration = 8.577 min.
Rainfall intensity = 3.438(In/Hr) for a 100.0 year storm
COMMERCIAL subarea type
Runoff Coefficient = 0.883
Decimal fraction soil group A = 0.000
Decimal fraction soil group B = 0.500
Decimal fraction soil group C = 0.500
Decimal fraction soil group D = 0.000
RI index for soil(AMC 2) = 62.50
Pervious area fraction = 0.100; Impervious fraction = 0.900
Initial subarea runoff = 9.230(CFS)
Total initial stream area = 3.040(Ac.)
Pervious area fraction = 0.100

Process from Point/Station 8.000 to Point/Station 9.000
**** PIPEFLOW TRAVEL TIME (Program estimated size) ****

Upstream point/station elevation = 1477.700(Ft.)
Downstream point/station elevation = 1475.900(Ft.)
Pipe length = 299.00(Ft.) Manning's N = 0.013
No. of pipes = 1 Required pipe flow = 9.230(CFS)
Nearest computed pipe diameter = 21.00(In.)
Calculated individual pipe flow = 9.230(CFS)
Normal flow depth in pipe = 13.57(In.)
Flow top width inside pipe = 20.08(In.)
Critical Depth = 13.57(In.)
Pipe flow velocity = 5.61(Ft/s)
Travel time through pipe = 0.89 min.
Time of concentration (TC) = 9.47 min.

Process from Point/Station 9.000 to Point/Station 9.000
**** CONFLUENCE OF MINOR STREAMS ****

Along Main Stream number: 2 in normal stream number 1
Stream flow area = 3.040(Ac.)
Runoff from this stream = 9.230(CFS)
Time of concentration = 9.47 min.
Rainfall intensity = 3.273(In/Hr)

Process from Point/Station 8.500 to Point/Station 9.000
**** INITIAL AREA EVALUATION ****

Initial area flow distance = 360.000(Ft.)
Top (of initial area) elevation = 1480.000(Ft.)
Bottom (of initial area) elevation = 1475.900(Ft.)
Difference in elevation = 4.100(Ft.)
Slope = 0.01139 s(percent)= 1.14
TC = $k(0.300)*[(length^3)/(elevation\ change)]^{0.2}$
Initial area time of concentration = 7.733 min.
Rainfall intensity = 3.621(In/Hr) for a 100.0 year storm
COMMERCIAL subarea type
Runoff Coefficient = 0.884
Decimal fraction soil group A = 0.000
Decimal fraction soil group B = 0.500
Decimal fraction soil group C = 0.500
Decimal fraction soil group D = 0.000
RI index for soil(AMC 2) = 62.50
Pervious area fraction = 0.100; Impervious fraction = 0.900
Initial subarea runoff = 10.592(CFS)
Total initial stream area = 3.310(Ac.)
Pervious area fraction = 0.100

Process from Point/Station 9.000 to Point/Station 9.000
 **** CONFLUENCE OF MINOR STREAMS ****

Along Main Stream number: 2 in normal stream number 2
 Stream flow area = 3.310(Ac.)
 Runoff from this stream = 10.592(CFS)
 Time of concentration = 7.73 min.
 Rainfall intensity = 3.621(In/Hr)
 Summary of stream data:

Stream No.	Flow rate (CFS)	TC (min)	Rainfall Intensity (In/Hr)
------------	-----------------	----------	----------------------------

1	9.230	9.47	3.273
2	10.592	7.73	3.621

Largest stream flow has longer or shorter time of concentration

Qp = 10.592 + sum of
 $Q_a \cdot \frac{T_b}{T_a}$
 $9.230 \cdot 0.817 = 7.540$
 Qp = 18.132

Total of 2 streams to confluence:
 Flow rates before confluence point:
 9.230 10.592

Area of streams before confluence:
 3.040 3.310

Results of confluence:
 Total flow rate = 18.132(CFS)
 Time of concentration = 7.733 min.
 Effective stream area after confluence = 6.350(Ac.)

 Process from Point/Station 9.000 to Point/Station 6.000
 **** PIPEFLOW TRAVEL TIME (Program estimated size) ****

Upstream point/station elevation = 1475.200(Ft.)
 Downstream point/station elevation = 1469.000(Ft.)
 Pipe length = 279.00(Ft.) Manning's N = 0.013
 No. of pipes = 1 Required pipe flow = 18.132(CFS)
 Nearest computed pipe diameter = 21.00(In.)
 Calculated individual pipe flow = 18.132(CFS)
 Normal flow depth in pipe = 13.79(In.)
 Flow top width inside pipe = 19.94(In.)
 Critical Depth = 18.59(In.)
 Pipe flow velocity = 10.83(Ft/s)
 Travel time through pipe = 0.43 min.
 Time of concentration (TC) = 8.16 min.

 Process from Point/Station 6.000 to Point/Station 6.000
 **** CONFLUENCE OF MAIN STREAMS ****

The following data inside Main Stream is listed:

In Main Stream number: 2
 Stream flow area = 6.350(Ac.)
 Runoff from this stream = 18.132(CFS)
 Time of concentration = 8.16 min.
 Rainfall intensity = 3.525(In/Hr)
 Program is now starting with Main Stream No. 3

 Process from Point/Station 4.750 to Point/Station 5.000
 **** INITIAL AREA EVALUATION ****

Initial area flow distance = 472.000(Ft.)
 Top (of initial area) elevation = 1480.000(Ft.)
 Bottom (of initial area) elevation = 1474.000(Ft.)
 Difference in elevation = 6.000(Ft.)
 Slope = 0.01271 s(percent) = 1.27
 $TC = k(0.300) \cdot [(length^3)/(elevation\ change)]^{0.2}$
 Initial area time of concentration = 8.431 min.
 Rainfall intensity = 3.468(In/Hr) for a 100.0 year storm
 COMMERCIAL subarea type
 Runoff Coefficient = 0.883
 Decimal fraction soil group A = 0.000
 Decimal fraction soil group B = 0.500
 Decimal fraction soil group C = 0.500
 Decimal fraction soil group D = 0.000
 RI index for soil(AMC 2) = 62.50
 Pervious area fraction = 0.100; Impervious fraction = 0.900
 Initial subarea runoff = 8.576(CFS)
 Total initial stream area = 2.800(Ac.)

Pervious area fraction = 0.100

Process from Point/Station 5.000 to Point/Station 6.000
**** PIPEFLOW TRAVEL TIME (Program estimated size) ****

Upstream point/station elevation = 1474.000(Ft.)
Downstream point/station elevation = 1469.000(Ft.)
Pipe length = 77.00(Ft.) Manning's N = 0.013
No. of pipes = 1 Required pipe flow = 8.576(CFS)
Nearest computed pipe diameter = 12.00(In.)
Calculated individual pipe flow = 8.576(CFS)
Normal flow depth in pipe = 9.28(In.)
Flow top width inside pipe = 10.05(In.)
Critical depth could not be calculated.
Pipe flow velocity = 13.15(Ft/s)
Travel time through pipe = 0.10 min.
Time of concentration (TC) = 8.53 min.

Process from Point/Station 6.000 to Point/Station 6.000
**** CONFLUENCE OF MAIN STREAMS ****

The following data inside Main Stream is listed:

In Main Stream number: 3
Stream flow area = 2.800(Ac.)
Runoff from this stream = 8.576(CFS)
Time of concentration = 8.53 min.
Rainfall intensity = 3.448(In/Hr)
Summary of stream data:

Stream No.	Flow rate (CFS)	TC (min)	Rainfall Intensity (In/Hr)
1	31.103	12.23	2.880
2	18.132	8.16	3.525
3	8.576	8.53	3.448

Largest stream flow has longer time of concentration

Qp = 31.103 + sum of
Qb Ia/Ib
18.132 * 0.817 = 14.815
Qb Ia/Ib
8.576 * 0.835 = 7.162
Qp = 53.080

Total of 3 main streams to confluence:

Flow rates before confluence point:
31.103 18.132 8.576
Area of streams before confluence:
11.670 6.350 2.800

Results of confluence:

Total flow rate = 53.080(CFS)
Time of concentration = 12.228 min.
Effective stream area after confluence = 20.820(Ac.)

Process from Point/Station 6.000 to Point/Station 10.000
**** PIPEFLOW TRAVEL TIME (Program estimated size) ****

Upstream point/station elevation = 1469.000(Ft.)
Downstream point/station elevation = 1467.000(Ft.)
Pipe length = 358.00(Ft.) Manning's N = 0.013
No. of pipes = 1 Required pipe flow = 53.080(CFS)
Nearest computed pipe diameter = 36.00(In.)
Calculated individual pipe flow = 53.080(CFS)
Normal flow depth in pipe = 32.25(In.)
Flow top width inside pipe = 21.99(In.)
Critical Depth = 28.41(In.)
Pipe flow velocity = 7.94(Ft/s)
Travel time through pipe = 0.75 min.
Time of concentration (TC) = 12.98 min.

Process from Point/Station 10.000 to Point/Station 10.000
**** CONFLUENCE OF MINOR STREAMS ****

Along Main Stream number: 1 in normal stream number 1
Stream flow area = 20.820(Ac.)
Runoff from this stream = 53.080(CFS)

Time of concentration = 12.98 min.
 Rainfall intensity = 2.795(In/Hr)

 Process from Point/Station 11.000 to Point/Station 12.000
 **** INITIAL AREA EVALUATION ****

Initial area flow distance = 197.000(Ft.)
 Top (of initial area) elevation = 1475.400(Ft.)
 Bottom (of initial area) elevation = 1471.200(Ft.)
 Difference in elevation = 4.200(Ft.)
 Slope = 0.02132 s(percent)= 2.13
 $TC = k(0.300)*[(length^3)/(elevation\ change)]^{0.2}$
 Initial area time of concentration = 5.360 min.
 Rainfall intensity = 4.350(In/Hr) for a 100.0 year storm
 COMMERCIAL subarea type
 Runoff Coefficient = 0.886
 Decimal fraction soil group A = 0.000
 Decimal fraction soil group B = 0.500
 Decimal fraction soil group C = 0.500
 Decimal fraction soil group D = 0.000
 RI index for soil(AMC 2) = 62.50
 Pervious area fraction = 0.100; Impervious fraction = 0.900
 Initial subarea runoff = 3.314(CFS)
 Total initial stream area = 0.860(Ac.)
 Pervious area fraction = 0.100

 Process from Point/Station 12.000 to Point/Station 10.000
 **** PIPEFLOW TRAVEL TIME (Program estimated size) ****

Upstream point/station elevation = 1471.200(Ft.)
 Downstream point/station elevation = 1467.000(Ft.)
 Pipe length = 93.00(Ft.) Manning's N = 0.013
 No. of pipes = 1 Required pipe flow = 3.314(CFS)
 Nearest computed pipe diameter = 9.00(In.)
 Calculated individual pipe flow = 3.314(CFS)
 Normal flow depth in pipe = 6.95(In.)
 Flow top width inside pipe = 7.55(In.)
 Critical depth could not be calculated.
 Pipe flow velocity = 9.05(Ft/s)
 Travel time through pipe = 0.17 min.
 Time of concentration (TC) = 5.53 min.

 Process from Point/Station 10.000 to Point/Station 10.000
 **** CONFLUENCE OF MINOR STREAMS ****

Along Main Stream number: 1 in normal stream number 2
 Stream flow area = 0.860(Ac.)
 Runoff from this stream = 3.314(CFS)
 Time of concentration = 5.53 min.
 Rainfall intensity = 4.282(In/Hr)
 Summary of stream data:

Stream No.	Flow rate (CFS)	TC (min)	Rainfall Intensity (In/Hr)
------------	-----------------	----------	----------------------------

1	53.080	12.98	2.795
2	3.314	5.53	4.282

Largest stream flow has longer time of concentration
 $Q_p = 53.080 + \text{sum of } Q_b \cdot \frac{I_a}{I_b}$
 $Q_p = 53.080 + 3.314 * 0.653 = 55.243$

Total of 2 streams to confluence:
 Flow rates before confluence point:
 53.080 3.314
 Area of streams before confluence:
 20.820 0.860
 Results of confluence:
 Total flow rate = 55.243(CFS)
 Time of concentration = 12.979 min.
 Effective stream area after confluence = 21.680(Ac.)
 End of computations, total study area = 21.68 (Ac.)
 The following figures maybe used for a unit hydrograph study of the same area.
 Area averaged pervious area fraction(Ap) = 0.100
 Area averaged RI index number = 62.5

Riverside County Rational Hydrology Program

CIVILCADD/CIVILDESIGN Engineering Software,(c) 1989 - 2014 Version 9.0
Rational Hydrology Study Date: 04/06/23 File:PRO2100.out

***** Hydrology Study Control Information *****

English (in-lb) Units used in input data file

Program License Serial Number 5006

Rational Method Hydrology Program based on
Riverside County Flood Control & Water Conservation District
1978 hydrology manual

Storm event (year) = 100.00 Antecedent Moisture Condition = 2

2 year, 1 hour precipitation = 0.500(In.)
100 year, 1 hour precipitation = 1.300(In.)

Storm event year = 100.0
Calculated rainfall intensity data:
1 hour intensity = 1.300(In/Hr)
Slope of intensity duration curve = 0.5000

Process from Point/Station 13.000 to Point/Station 14.000
**** INITIAL AREA EVALUATION ****

Initial area flow distance = 287.000(Ft.)
Top (of initial area) elevation = 1485.000(Ft.)
Bottom (of initial area) elevation = 1482.000(Ft.)
Difference in elevation = 3.000(Ft.)
Slope = 0.01045 s(percent)= 1.05
TC = $k(0.940)*[(length^3)/(elevation\ change)]^{0.2}$
Initial area time of concentration = 22.513 min.
Rainfall intensity = 2.122(In/Hr) for a 100.0 year storm
UNDEVELOPED (good cover) subarea
Runoff Coefficient = 0.691
Decimal fraction soil group A = 0.000
Decimal fraction soil group B = 0.500
Decimal fraction soil group C = 0.500
Decimal fraction soil group D = 0.000
RI index for soil(AMC 2) = 67.50
Pervious area fraction = 1.000; Impervious fraction = 0.000
Initial subarea runoff = 0.953(CFS)
Total initial stream area = 0.650(Ac.)
Pervious area fraction = 1.000
End of computations, total study area = 0.65 (Ac.)
The following figures may
be used for a unit hydrograph study of the same area.

Area averaged pervious area fraction(Ap) = 1.000
Area averaged RI index number = 67.5

POST-DEVELOPMENT HYDROLOGY MAP RAMONA EXPRESSWAY AND WEBSTER AVENUE

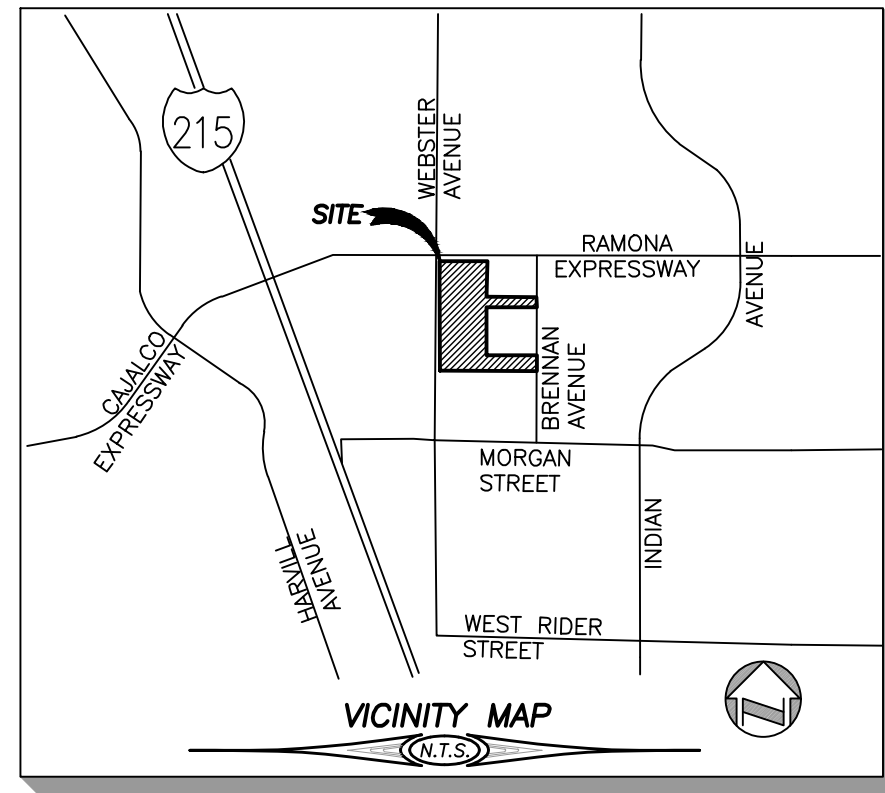

LEGEND

- DRAINAGE AREA BOUNDARY
- FLOW PATH
- FLOW ARROW

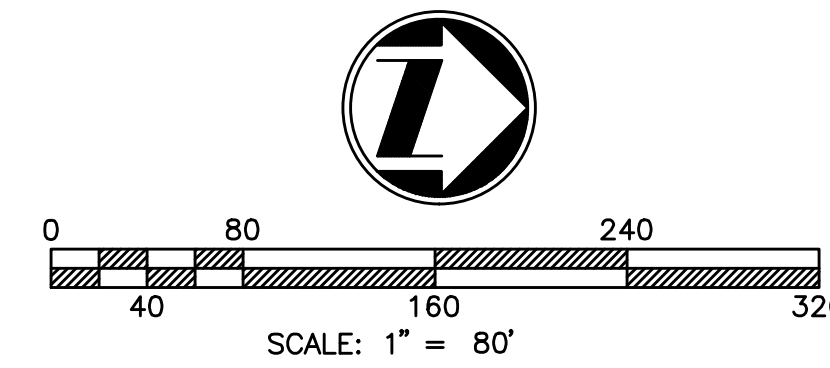
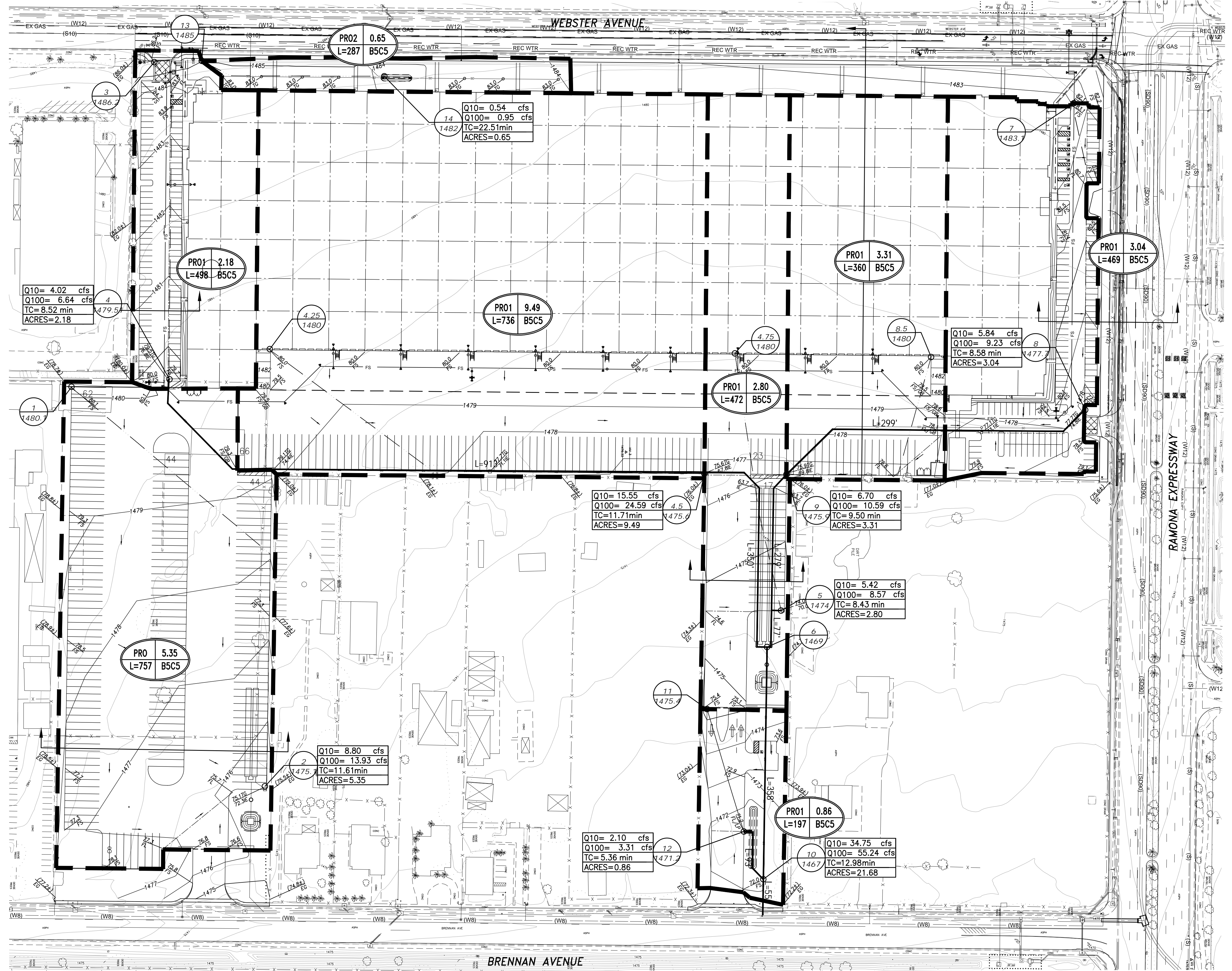

POST DEVELOPMENT
HYDROLOGY MAP
PREPARATION DATE: MARCH 2023
REVISION DATE: MAY 2023
JOB NUMBER: 10331
PLANS PREPARED BY:
adkan ENGINEERS
Civil Engineering • Surveying • Planning
6879 Airport Drive, Riverside, CA 92504
Tel: (951) 688-0241 • Fax: (951) 688-0599

Section 3

Inlet Calculations

NODE 2

Worksheet for Curb Inlet In Sag

Project Description	
Worksheet	NODE 2
Type	Curb Inlet In Sag
Solve For	Spread

Input Data	
Discharge	13.93 cfs
Gutter Width	1.00 ft
Gutter Cross Slope	0.080000 ft/ft
Road Cross Slope	0.020000 ft/ft
Curb Opening Length	21.00 ft
Opening Height	0.67 ft
Curb Throat Type	Horizontal
Local Depression	4.0 in
Local Depression Width	2.00 ft

Results	
Spread	19.64 ft
Throat Incline Angle	90.00 degrees
Depth	0.45 ft
Gutter Depression	0.7 in
Total Depression	4.7 in

NODE 4

Worksheet for Combination Inlet On Grade

Project Description	
Worksheet	NODE 4
Type	Combination Inlet On Grade
Solve For	Efficiency

Input Data	
Discharge	6.64 cfs
Local Depression	4.0 in
Local Depression Width	2.00 ft
Slope	0.005000 ft/ft
Gutter Width	2.00 ft
Gutter Cross Slope	0.080000 ft/ft
Road Cross Slope	0.020000 ft/ft
Mannings Coefficient	0.013
Curb Opening Length	14.00 ft
Grate Width	2.00 ft
Grate Length	2.00 ft
Grate Type	P-50 mm (P-1-7/8")
Clogging	50.0 %

Options	
Calculation Option	Use Both
Grate Flow Option	Exclude None

Results	
Efficiency	1.00
Intercepted Flow	6.64 cfs
Bypass Flow	0.00 cfs
Spread	14.78 ft
Depth	0.07 ft
Flow Area	3.4e-2 ft ²
Gutter Depression	1.4 in
Total Depression	5.4 in
Velocity	1.07 ft/s
Splash Over Velocity	5.66 ft/s
Frontal Flow Factor	1.00
Side Flow Factor	0.11
Grate Flow Ratio	1.00
Equivalent Cross Slope	0.110464 ft/ft
Active Grate Length	1.00 ft
Length Factor	0.94
Total Interception Length	13.77 ft

NODE 4.5

Worksheet for Combination Inlet In Sag

Project Description	
Worksheet	NODE 4.5
Type	Combination Inlet In Sag
Solve For	Spread
Input Data	
Discharge	24.59 cfs
Local Depression	4.0 in
Local Depression Width	2.00 ft
Gutter Width	2.00 ft
Gutter Cross Slope	0.080000 ft/ft
Road Cross Slope	0.020000 ft/ft
Curb Opening Length	21.00 ft
Opening Height	0.67 ft
Curb Throat Type	Horizontal
Grate Width	2.00 ft
Grate Length	2.00 ft
Grate Type	P-50 mm (P-1-7/8")
Clogging	50.0 %
Options	
Calculation Option	Use Both
Results	
Spread	21.12 ft
Throat Incline Angle	90.00 degrees
Depth	0.54 ft
Gutter Depression	1.4 in
Total Depression	5.4 in
Open Grate Area	1.8 ft ²
Active Grate Weir Length	4.00 ft

NODE 5

Worksheet for Curb Inlet In Sag

Project Description

Worksheet	NODE 5
Type	Curb Inlet In Sag
Solve For	Spread

Input Data

Discharge	8.57 cfs
Gutter Width	1.00 ft
Gutter Cross Slope	0.080000 ft/ft
Road Cross Slope	0.020000 ft/ft
Curb Opening Length	21.00 ft
Opening Height	0.67 ft
Curb Throat Type	Horizontal
Local Depression	4.0 in
Local Depression Width	2.00 ft

Results

Spread	14.21 ft
Throat Incline Angle	90.00 degrees
Depth	0.34 ft
Gutter Depression	0.7 in
Total Depression	4.7 in

NODE 8

Worksheet for Curb Inlet In Sag

Project Description

Worksheet	NODE 8
Type	Curb Inlet In Sag
Solve For	Spread

Input Data

Discharge	9.23 cfs
Gutter Width	1.00 ft
Gutter Cross Slope	0.080000 ft/ft
Road Cross Slope	0.020000 ft/ft
Curb Opening Length	14.00 ft
Opening Height	0.67 ft
Curb Throat Type	Horizontal
Local Depression	4.0 in
Local Depression Width	2.00 ft

Results

Spread	18.66 ft
Throat Incline Angle	90.00 degrees
Depth	0.43 ft
Gutter Depression	0.7 in
Total Depression	4.7 in

NODE 9

Worksheet for Curb Inlet In Sag

Project Description	
Worksheet	NODE 9
Type	Combination Inlet On Grade
Solve For	Efficiency

Input Data	
Discharge	10.59 cfs
Local Depression	4.0 in
Local Depression Width	2.00 ft
Slope	0.005000 ft/ft
Gutter Width	2.00 ft
Gutter Cross Slope	0.080000 ft/ft
Road Cross Slope	0.020000 ft/ft
Mannings Coefficient	0.013
Curb Opening Length	21.00 ft
Grate Width	2.00 ft
Grate Length	2.00 ft
Grate Type	P-50 mm (P-1-7/8")
Clogging	50.0 %

Options	
Calculation Option	Use Both
Grate Flow Option	Exclude None

Results	
Efficiency	1.00
Intercepted Flow	10.59 cfs
Bypass Flow	0.00 cfs
Spread	17.85 ft
Depth	0.48 ft
Flow Area	0.0 ft ²
Gutter Depression	1.4 in
Total Depression	5.4 in
Velocity	0.00 ft/s
Splash Over Velocity	5.66 ft/s
Frontal Flow Factor	1.00
Side Flow Factor	1.00
Grate Flow Ratio	1.00
Equivalent Cross Slope	0.094884 ft/ft
Active Grate Length	1.00 ft
Length Factor	1.09
Total Interception Length	18.35 ft

NODE 12

Worksheet for Curb Inlet In Sag

Project Description	
Worksheet	NODE 12
Flow Element	Rectangular Channel
Method	Manning's Formula
Solve For	Channel Depth

Input Data	
Mannings Coefficient	0.013
Slope	0.005000 ft/ft
Bottom Width	7.00 ft
Discharge	3.31 cfs

Results	
Depth	0.19 ft
Flow Area	1.3 ft ²
Wetted Perimeter	7.37 ft
Top Width	7.00 ft
Critical Depth	0.19 ft
Critical Slope	0.004591 ft/ft
Velocity	2.54 ft/s
Velocity Head	0.10 ft
Specific Energy	0.29 ft
Froude Number	1.04
Flow Type	Supercritical

Section 4

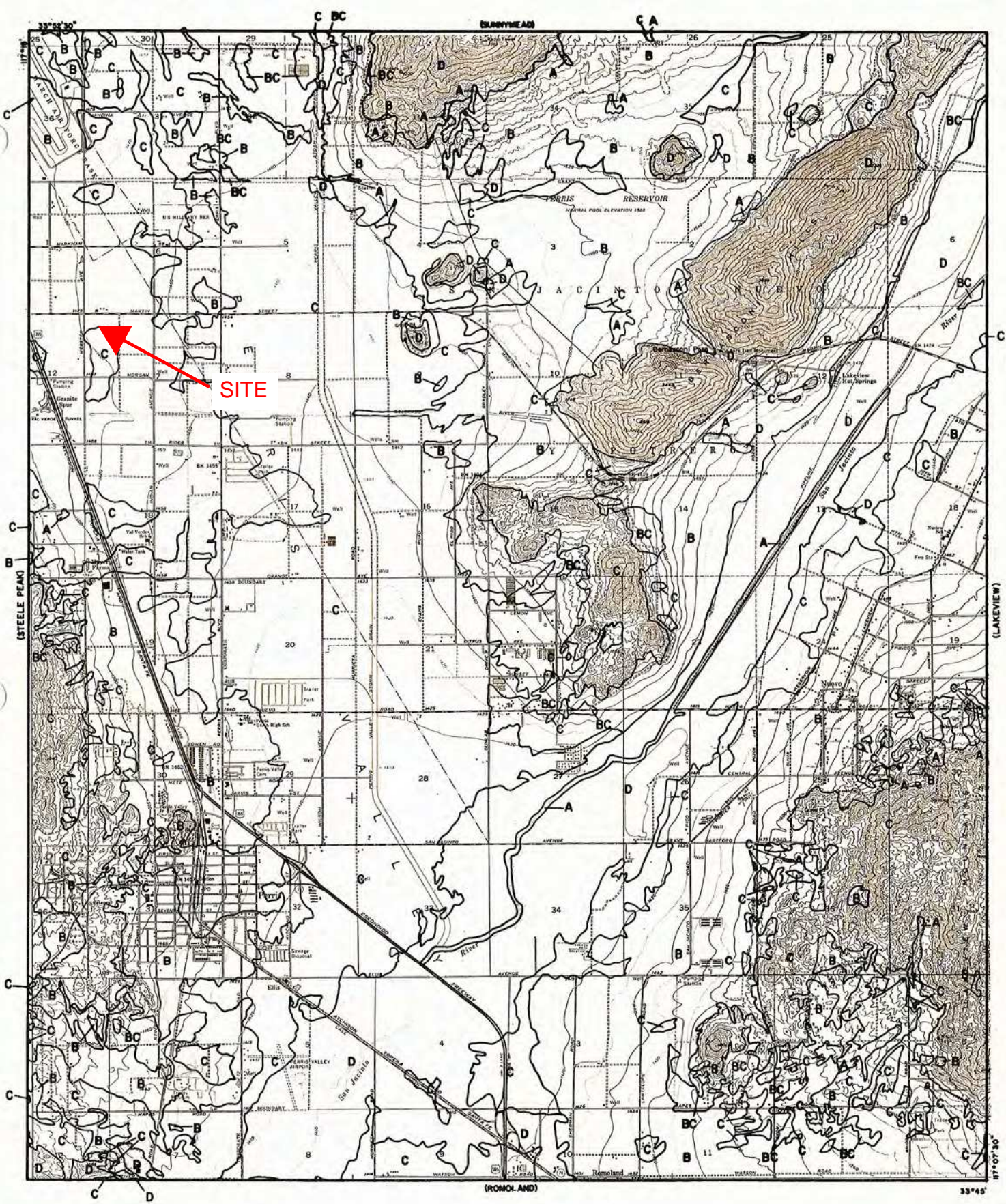

Riverside County Plates



LEGEND

— SOILS GROUP BOUNDARY
 A SOILS GROUP DESIGNATION

RCFC & WCD
 HYDROLOGY MANUAL



 0 FEET 5000

**HYDROLOGIC SOILS GROUP MAP
 FOR
 PERRIS**

B-50%
 C-50%

RUNOFF INDEX NUMBERS OF HYDROLOGIC SOIL-COVER COMPLEXES FOR PERVIOUS AREAS-AMC II

Cover Type (3)	Quality of Cover (2)	Soil Group			
		A	B	C	D
<u>NATURAL COVERS -</u>					
Barren (Rockland, eroded and graded land)		78	86	91	93
Chaparrel, Broadleaf (Manzonita, ceanothus and scrub oak)	Poor	53	70	80	85
	Fair	40	63	75	81
	Good	31	57	71	78
Chaparrel, Narrowleaf (Chamise and redshank)	Poor	71	82	88	91
	Fair	55	72	81	86
Grass, Annual or Perennial	Poor	67	78	86	89
	Fair	50	69	79	84
	Good	38	61	74	80
Meadows or Cienegas (Areas with seasonally high water table, principal vegetation is sod forming grass)	Poor	63	77	85	88
	Fair	51	70	80	84
	Good	30	58	72	78
Open Brush (Soft wood shrubs - buckwheat, sage, etc.)	Poor	62	76	84	88
	Fair	46	66	77	83
	Good	41	63	75	81
Woodland (Coniferous or broadleaf trees predominate. Canopy density is at least 50 percent)	Poor	45	66	77	83
	Fair	36	60	73	79
	Good	28	55	70	77
Woodland, Grass (Coniferous or broadleaf trees with canopy density from 20 to 50 percent)	Poor	57	73	82	86
	Fair	44	65	77	82
	Good	33	58	72	79
<u>URBAN COVERS -</u>					
Residential or Commercial Landscaping (Lawn, shrubs, etc.)	Good	32	56	69	75
Turf (Irrigated and mowed grass)	Poor	58	74	83	87
	Fair	44	65	77	82
	Good	33	58	72	79
<u>AGRICULTURAL COVERS -</u>					
Fallow (Land plowed but not tilled or seeded)		76	85	90	92

RCFC & WCD
HYDROLOGY MANUAL

**RUNOFF INDEX NUMBERS
FOR
PERVIOUS AREA**

ACTUAL IMPERVIOUS COVER

Land Use (1)	Range-Percent	Recommended Value For Average Conditions-Percent (2)
Natural or Agriculture	0 - 10	0
Single Family Residential: (3)		
40,000 S. F. (1 Acre) Lots	10 - 25	20
20,000 S. F. (½ Acre) Lots	30 - 45	40
7,200 - 10,000 S. F. Lots	45 - 55	50
Multiple Family Residential:		
Condominiums	45 - 70	65
Apartments	65 - 90	80
Mobile Home Park	60 - 85	75
Commercial, Downtown Business or Industrial	80 -100	90

Notes:

1. Land use should be based on ultimate development of the watershed. Long range master plans for the County and incorporated cities should be reviewed to insure reasonable land use assumptions.
2. Recommended values are based on average conditions which may not apply to a particular study area. The percentage impervious may vary greatly even on comparable sized lots due to differences in dwelling size, improvements, etc. Landscape practices should also be considered as it is common in some areas to use ornamental gravels underlain by impervious plastic materials in place of lawns and shrubs. A field investigation of a study area should always be made, and a review of aerial photos, where available may assist in estimating the percentage of impervious cover in developed areas.
3. For typical horse ranch subdivisions increase impervious area 5 percent over the values recommended in the table above.

RCFC & WCD
HYDROLOGY MANUAL

**IMPERVIOUS COVER
FOR
DEVELOPED AREAS**

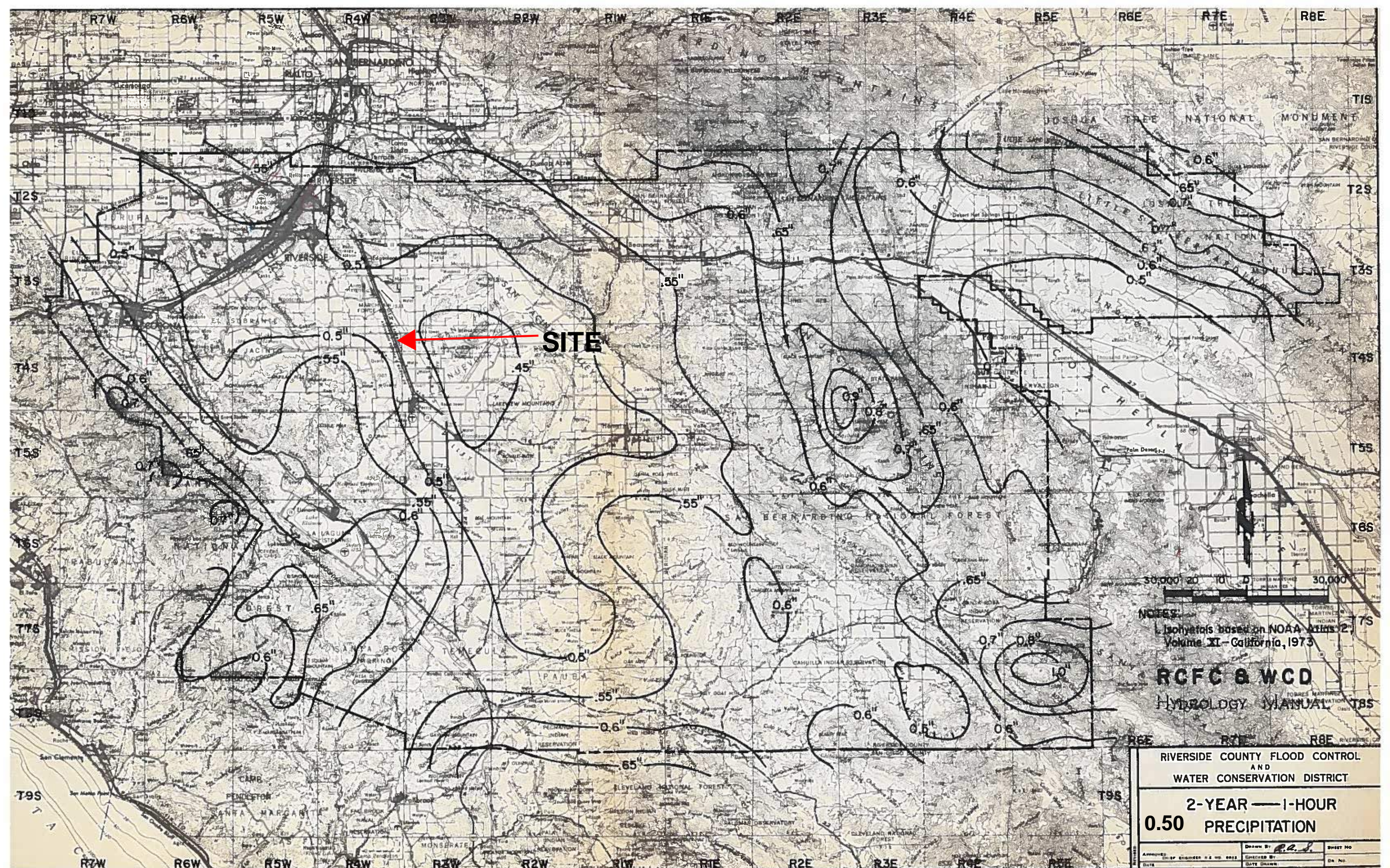

SITE

NOTES:
 Isohyets based on NOAA Atlas 2,
 Volume XI - California, 1973

RCFC & WCD
 HYDROLOGY MANUAL

RIVERSIDE COUNTY FLOOD CONTROL
 AND
 WATER CONSERVATION DISTRICT

**2-YEAR — 1-HOUR
 0.50 PRECIPITATION**

APPROVED	DATE	ENGINEER	NO.	DATE	DRAWN	BY	DATE	SHEET	NO.

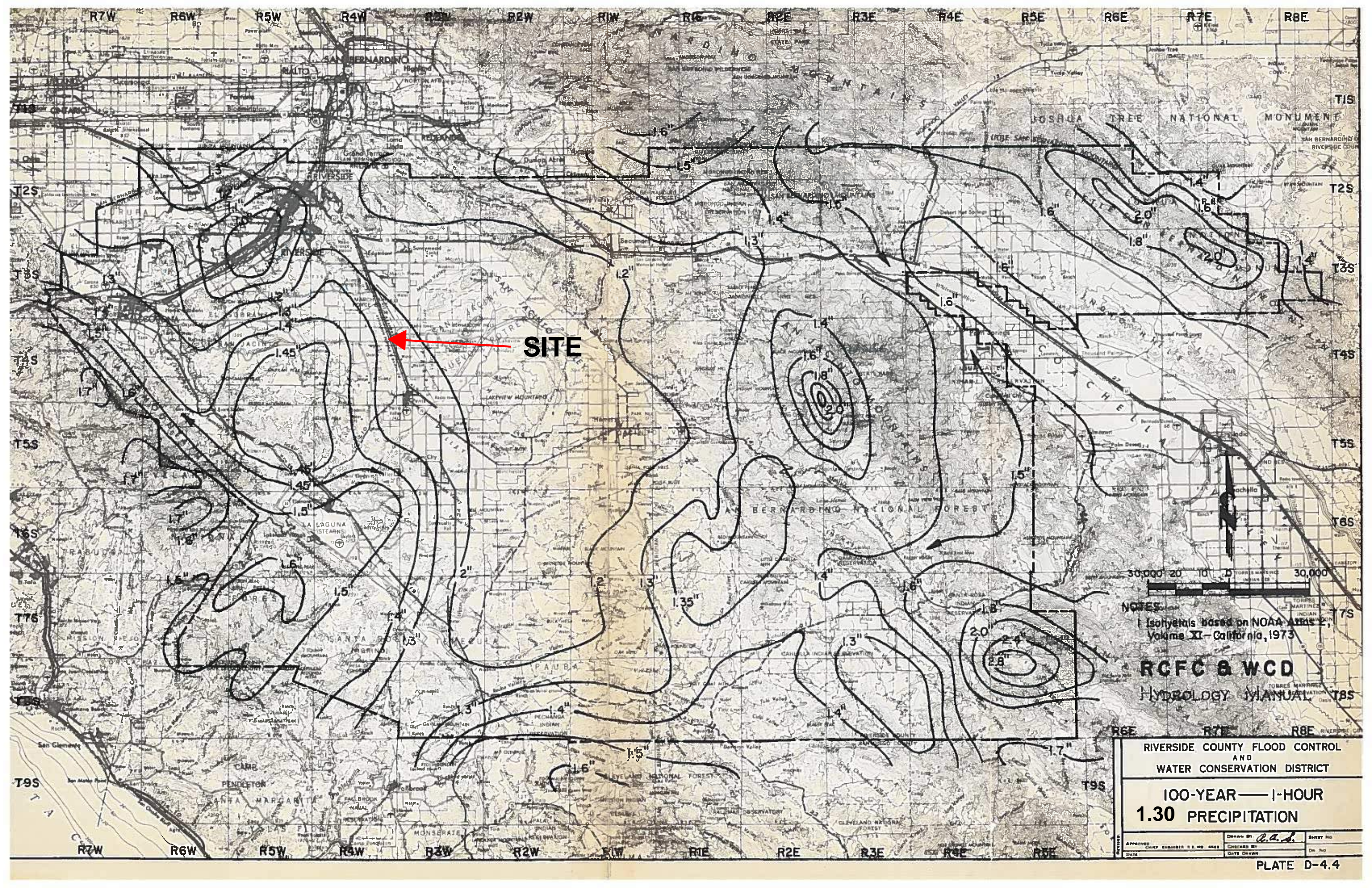

SITE

NOTES:
 1. Isohyets based on NOAA Atlas 14, Volume XI - California, 1973

RCFC & WCD
 HYDROLOGY MANUAL

RIVERSIDE COUNTY FLOOD CONTROL
 AND
 WATER CONSERVATION DISTRICT

**100-YEAR — 1-HOUR
 1.30 PRECIPITATION**

APPROVED	CHIEF ENGINEER	DATE	DRAWN BY	DATE	SHEET NO.
			<i>R.A.S.</i>		

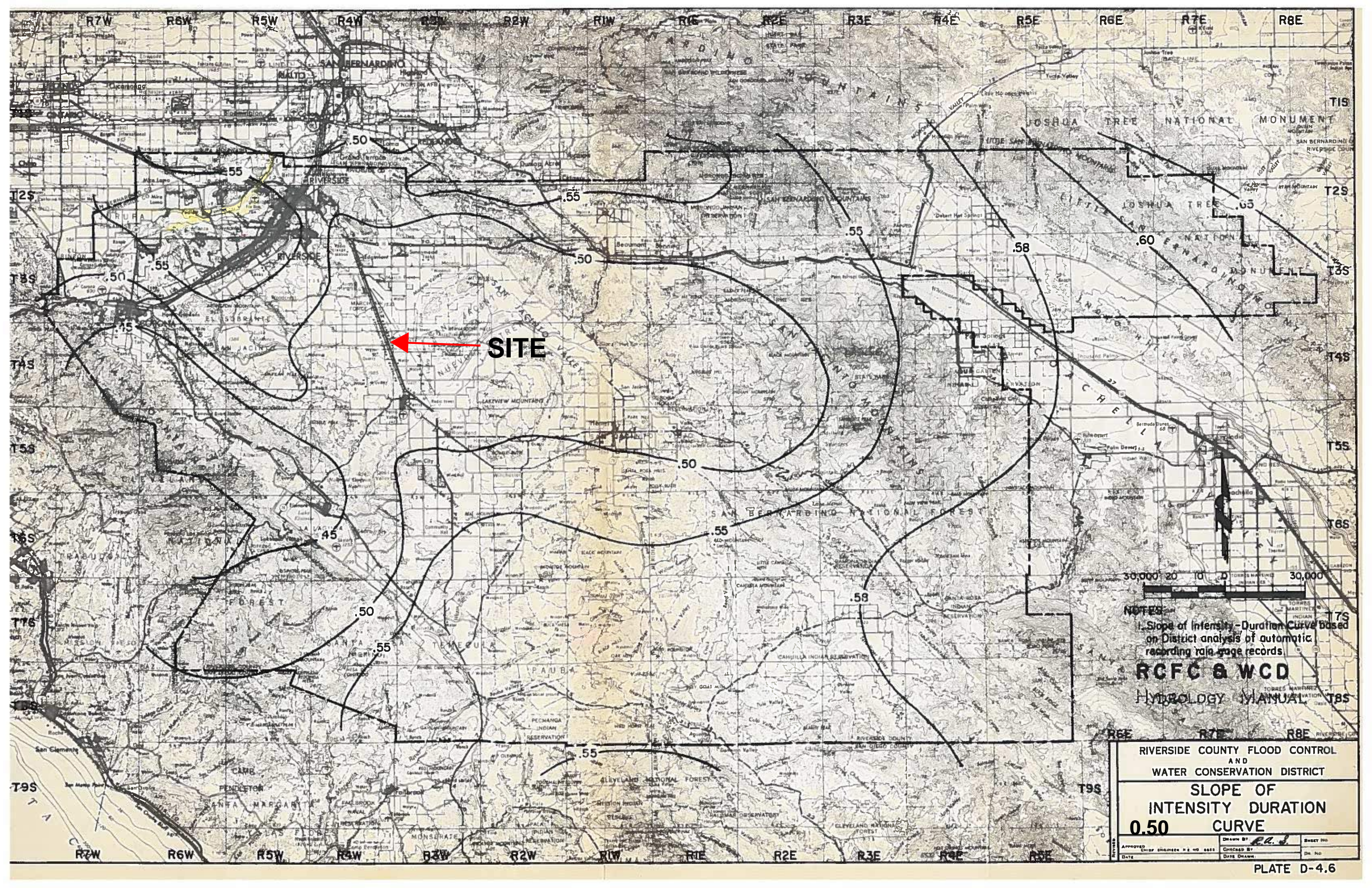

← SITE

NOTES
 1. Slope of Intensity-Duration Curve Based on District analysis of automatic recording rain gage records.

RCFC & WCD
 HYDROLOGY MANUAL

RIVERSIDE COUNTY FLOOD CONTROL AND WATER CONSERVATION DISTRICT		
SLOPE OF INTENSITY DURATION CURVE		
0.50		
APPROVED CHIEF ENGINEER R. E. NO. 6663	DRAWN BY <i>R. J.</i>	SHEET NO.
DATE	CHECKED BY	DR. NO.
	DATE DRAWN	