

**City of Perris**  
**Department of Development Service**  
**Office of the Fire Marshal**  
**135 North "D" Street, Perris CA. 92570**  
**Phone: (951) 443-1029 Fax: (951) 943-3293**

# **Fire Department Access & Water Requirements for Commercial & Residential Development**

## **PURPOSE**

The effectiveness of emergency response and firefighting operations is directly related to the proper installation and maintenance of fire access roadways, the proper sitting of hydrants, adequate water supply, and access to structures. This document is a general guideline pertaining to the creation and maintenance of fire department access roadways, access walkways to and around buildings, and hydrant quantity and placement as required by the 2022 California Fire and Building Codes (CFC and CBC) and as amended by local ordinance. This guideline includes requirements for:

- Plan submittal
- Fire access roadway design
- Fire lane identification
- Premises identification
- Fire lane obstructions
- Access for residential development
- Alternative engineered fire access systems
- Hydrant quantity, spacing, placement, and identification
- Water availability and fire flow
- Access to structures
- Access during construction

## **SCOPE**

This guideline applies to new, remodeled, reconstructed, or relocated residential or commercial structures and developments to which emergency response may be necessary. The information contained in this document is intended to assist the applicant in attaining compliance and to ensure that privately owned roadways necessary for emergency response purposes will be available for use at all times. Some of the issues discussed within this document may be covered in more detail through other Perris guidelines.

The following definitions are provided to facilitate the consistent application of this guideline:

*Access Walkways* - An approved walking surface leading from fire access roadways to exterior doors, the area beneath rescue windows, and other required openings in structures.

*Bollards* - Permanent or removable poles that are placed across a roadway for restricting vehicular access to a portion of a site or to protect a piece of equipment from potential vehicular damage. Bollards are not permitted across a fire access roadway.

*Fire Apparatus Access Roads* - The means for emergency apparatus to access a facility or structure for emergency purposes. Roadways must extend to within 150 feet of all portions of the exterior of the first floor of any structure and must meet specified criteria for width, pavement characteristics, roadway gradient, turning radius, etc. Fire apparatus access roads are also referred to as fire lanes.

*Fire Lane Identification* – Signs or curb markings that allow fire apparatus access roads to be readily recognized so that they will remain unobstructed and available for emergency use at all times.

*Gates and Barriers* - Devices that restrict pedestrian and vehicle ingress and egress to and from a facility.

*Gate and Barrier Locks* - Devices that are installed on gates and barriers to secure a property or facility.

*Hose Pull* – The effective distance (150 feet) that firefighters can drag a hose from fire apparatus to attack a fire. Hose pull is measured along a simulated path of travel accounting for obstructions and not “as the crow flies.” See Attachments 23.

*Premises Identification* - The visual means (address numbers) used to readily identify a property or facility street address. It may also be used to distinguish separate buildings within a single facility or property.

*Rescue Openings* – Exterior doors or windows required in all sleeping rooms in R occupancies located below the fourth story of a building that allow rescue of trapped occupants.

## **SUBMITTAL REQUIREMENTS**

### **1. Plan Submittal Requirements**

Plans shall be provided to demonstrate compliance with all codes and other regulations governing water availability for firefighting and emergency access to sites

and structures within the City of Perris. In addition, changes to existing structures or sites shall be reviewed by the City of Perris Office of the Fire Marshal (OFM) to ensure that the modifications do not affect water availability or access.

- A. Submittals – Two plan sets will need to be submitted to the City of Perris Building Department. The Perris plan review and inspection fees are due upon submittal of the plans.
- B. Scope – The scope of work shall be clearly indicated on the plan. If the building or site in question was approved previously, include the Perris permit number of that prior approval on the new plans. A copy of the previously approved fire master plan shall be submitted along with new plan sets for any revision.
- C. Building Data – Information related to the building’s location, use, and construction shall be clearly indicated on the plan.
  - 1) Include the project’s street address (or a working address of the job trailer or future building on the site when not known) and the tract, tentative tract, or parcel map number (this is NOT the County Assessor’s parcel number or APN).
  - 2) Indicate the types of occupancies that will be housed in the structure as listed in California Building Code (CBC) Chapter 3.
  - 3) Indicate the building height on the plans as defined in CBC. If the building height is greater than 50 feet, also indicate the elevation change (measured from finished floor to finished floor) between the lowest floor giving access to the structure and the highest occupied floor or occupied roof deck.
  - 4) Note the type of sprinkler system installed/proposed (e.g., NFPA 13, 13-R, or 13-D).
- D. Required Plan Notes – Include the Perris Fire Department Access & Water Notes on the plan. See Attachment 1.
- E. Water Availability – To facilitate the review process and avoid untimely delays in project approval, applicants are strongly encouraged to arrange a hydrant flow test with the water company prior to submitting plans to the City of Perris if the project includes a new structure or increase in the floor area of an existing structure. Water availability information may not be required to be submitted for every project, and plans may be submitted with a hydrant flow test pending, but the applicant should understand that project approval may be delayed if it is determined during review that this information is required. If the project requires evaluation of the available fire flow, it will not be approved without a completed Perris Water Availability form or equivalent data sheets from a water district. Water availability information must be no older than twelve months.

- F. Conditions of Approval – To ensure consistency of the fire access plan with project conditions, include any conditions of approval pertaining to the review of the project on the plans. If the project does not require review and entitlement by the Planning Commission, City Council, or the Planning Department permit review process is required but has not yet been completed, please state this on the plan. If you are unsure whether your project requires planning approval, please contact the Planning Department.
- G. Complete Attachment 2, Fire Master Plan Submittal Checklist, and verify that basic project information has been provided and that general access and water requirements have been addressed on the plan.

## 2. Fire Access Roadways

Fire access roadways, commonly referred to as fire lanes, shall be provided for every facility or building when any portion of an exterior wall of the first story is located more than 150 feet from a public roadway, as measured along an approved route. Extenuating circumstances, increased hazards, and additional fire safety features may affect these requirements. CFC 503.1

- A. Fire Apparatus Access Road Design - Fire access roadways must be engineered to support emergency response apparatus. Roadways must be designed to facilitate turning radii of apparatus and meet requirements for gradient, height clearance, and width. Specific criteria pertaining to the design of fire access roadways are detailed below.
  - 1) Fire access roadways shall be designed, constructed, and maintained to support the imposed loads of Perris fire apparatus with a total weight of 75,000 pounds. Apparatus weight is distributed as 50,000 pounds on tandem rear axles and 25,000 pounds on the front axle. The surface shall be designed, constructed, and maintained to provide all-weather driving capabilities. *A letter or statement, wet-stamped and signed by a registered engineer, shall be provided on the plans certifying that any new roadway meets this 75,000-pound, all-weather requirement.* Road base without an appropriate topping or binding material does not satisfy the all-weather requirement.
  - 2) Number of Fire Apparatus Access Roads Required:
    - a) One is required if any portion of an exterior wall of the first story of a building is located more than 150 feet from a fire access roadway. That access is to be measured by an approved route around the exterior of the building (see Section 9: Access to Structures).
    - b) More than one road is required if it is determined that access by a single road may be insufficient due to terrain, location, travel distance, potential

fire or life-safety hazards, or other factors that could limit access or if vehicle congestion, railways, or weather conditions could impair the single-entry point. Supplementary access points shall be located to facilitate evacuation and emergency operations and minimize congestion or obstruction during an emergency incident.

- i. A minimum of two vehicle access points is required for any development containing 150 or more residential units.
- ii. A secondary access point may also be required for commercial projects more than 100,000 sq.ft. in building area. Requirements may vary depending on factors such as building use, expected vehicle and occupant load on site, traffic stacking, or impact on surrounding streets.

### 3) Location of Fire Apparatus Access Roads:

For purposes of determining the suitability of public roads and fire access roadways for staging fire apparatus and facilitating fire suppression operations for a particular structure, the following criteria shall apply:

- a) To protect fire apparatus, personnel, and equipment from damage and injury from falling debris, the edge of fire access roadways serving multi-story buildings should be located no closer than 10 to 30 feet from the building, the actual distance being a function of overall building height with consideration given to building construction, presence of openings, and other potential hazards. As distances greater than 40 feet inhibit the use of vehicle-mounted ladders while distances closer than 20 feet do not allow for a proper laddering angle, the edge of fire lanes serving structures four or more stories in height shall be located between 20 and 40 feet from the building. These distances are measured from the face of the building to the top edge of the curb face or rolled curb flow line nearest the structure. To ensure that vehicular access and egress from dead-end fire access roadways serving multi-story buildings are maintained at all times, staging areas shall be provided along the roadway to permit fire apparatus to pass ladder trucks that have outriggers extended. Consideration shall be given to the length of the roadway, roof and building design, obstructions to laddering, and other operational factors in determining the number, location, and configuration of such staging areas.
- b) Access may be taken from an on-site fire apparatus access road or from a public road with an average daily trip (ADT) count below 30,000 unless an irrevocable recorded access easement agreement is in effect to obtain access from adjacent properties. Contact the city Traffic Engineer's Office or Public Works Department for ADT information.

- c) Public roads with an ADT count of 30,000 or more may be acceptable as a fire department access point serving an adjacent site when certain conditions and features (e.g., vehicle turnouts, acceleration/deceleration lanes) are present that limit the hazard to firefighters and other drivers. Such access roads will be evaluated on a case-by-case basis.
- 4) Width of Fire Access Roads - The minimum width of a fire access roadway is 20 feet. If a center median is included, the required width shall be provided on both sides of the median.
- 5) Parking Restrictions - No parking is permitted on roadways that are narrower than 28 feet in width. Parking on one side is permitted on a roadway that is at least 28 feet but less than 36 feet in width. Parking on two sides is permitted on a roadway 36 feet or more in width. These restrictions apply to all roads serving as fire lanes. See Attachment 3.
- 6) Vertical Clearance - Fire access roads shall have an unobstructed vertical clearance of not less than 13 feet 6 inches. If trees are located adjacent to the fire access roadway, place a note on the plans stating that all vegetation overhanging the fire access roadway shall be maintained to provide a clear height of 13 feet 6 inches at all times. See Attachments 4 and 5.
- 7) Fire Apparatus Access Road Grade - The grade for access roads shall not exceed 10% or 5.7 degrees. Cross-slope shall not be greater than 2% for paved access roadways.
- 8) Inside and Outside Turning Radii - The inside turning radius for an access road shall be 32 feet or greater. Where the access roadway is 26 feet wide the inside turning radius can be reduce to 20 feet. The outside turning radius for an access road shall be 45 feet or greater. As fire apparatus are unable to negotiate tight "S" curves, a 56-foot straight leg must be provided between these types of compound turns or the radii and/or road width must be increased accordingly. See Attachment 6.
- 9) Dead-end Access Roadways - Dead-end roadways in excess of 150 feet shall be designed and constructed with approved turnarounds or hammerheads. Turnarounds shall meet the turning radius requirements identified above. The minimum cul-de-sac radius is 45 feet with no parking allowed. The maximum length of a cul-de-sac road without mid-way turnarounds or other mitigating features is 800 feet. See Attachment 7.
- 10) Bridges - When a bridge is required as part of an access road, it shall be a minimum of 20' in width and designed and constructed to accommodate a total weight of 75,000 pounds. Apparatus weight is distributed as 50,000 pounds on tandem rear axles and 25,000 pounds on the front axle.

- 11) Median breaks - Where medians or raised islands are proposed that prevent emergency apparatus from crossing over into opposing traffic lanes, breaks or pass-throughs may be required to be provided. The location and design specifications for the pass-through shall be coordinated with the city public works or engineering department.

### 3. Fire Access Roadway Identification

Fire lane identification will be required when it is necessary to restrict parking of vehicles in order to maintain the required width of fire access roadways for emergency vehicle use. Unlawful use of fire lanes will be enforced by the local law enforcement agency in accordance with the California Vehicle Code (CVC). See Attachment 8.

- A. Sign and Curb Marking Options - Areas designated as a fire lane require an acceptable method of marking that shall be approved prior to installation. Examples of dimensions and acceptable options for signage installations and markings are found in Attachments 9 through 14. The following methods are acceptable means of identifying designated fire lanes for public and private streets. Choose either option 1 OR option 2 below.

- 1 - Specific areas designated by Perris as fire lanes must be marked with red curbs meeting the specifications in Attachment 9. In addition, where the number of entrances into the area marked with fire lanes is limited, all such vehicle entrances to the designated area shall be posted with approved fire lane entrance signs meeting the specifications in Attachment 10. This option is preferred by the OFM.
- 2 - "Fire Lane—No Parking" signs meeting the specifications in Attachment 11 shall be posted immediately adjacent to each designated fire lane and at intervals not to exceed 50 feet. See Attachment 12. In addition, where the number of entrances into the area marked with fire lanes is limited, all such vehicle entrances to the designated area shall be posted with approved fire lane entrance signs.

*Note: All alternative signs must be approved through the Perris Fire Prevention Bureau, City of Perris and by the city engineer and/or police agency, as applicable.*

### 4. Premises Identification

Three possible configurations of buildings or units within a building may exist and are identified as follows: freestanding buildings, multi-unit buildings, or multi-building clusters. Common to all configurations are the following requirements:

- A. Approved numbers or addresses shall be placed on the front elevation of all new or existing buildings in such a position that is plainly visible and legible from the

street or road on which the property is addressed. Addresses shall not be located where they have the potential of being obstructed by signs, awnings, vegetation, or other building/site elements. An address monument at the vehicle entrance or other location clearly visible and legible from the public road may be provided in lieu of an address on the structure where only a single building with a single street address is present and no other structures are accessible from the fire lane serving that structure. CBC 501.2, CFC 505.1

- B. The numbers shall contrast with their background.
- C. The numbers shall be a minimum of 4 inches or more in height for single-family residential structures/duplexes, or individual unit numbers in multi-family residential structures and 8 inches or more for commercial structures or the primary building address or address range posted on multi-family residential structures. The numbers shall have a one-inch stroke or as required by local ordinance, whichever is more restrictive. Buildings that are set back from the primary roads more than 150 feet shall have number a minimum of 12" in height.
- D. Numbers for new buildings shall be illuminated to be visible at night.
- E. Where it is unclear as to which street a building is addressed to (e.g., a building is accessed only from a street other than the one it is addressed to; multiple main entrances to the site or building itself front different streets), the name of the street shall also be identified as part of the posted address.

In addition to common requirements specified above, the following additional requirements pertain to each building configuration:

- F. Multi-Unit Buildings - Suite/apartment numbers shall be placed on or adjacent to the primary entrance for each suite/apartment and any other door providing access to fire department personnel during an emergency. Multiple residential and commercial units having entrance doors not visible from the street or road shall, in addition, have approved numbers grouped for all units within each structure and positioned to be plainly visible from the street or road.
- G. Multi-Building Clusters - Approved numbers or addresses shall be placed on the front elevation(s) of all buildings that form the cluster. If all building addresses are not clearly visible or legible from the public road serving the structures, an address monument shall also be provided at the entry point(s) to the site indicating the range of addresses accessible from that entrance.

## **5. Obstructions to Emergency Vehicle Access**

Existing or proposed gates and barriers crossing fire apparatus access roadways must be shown on the plans. Information such as the location, type of gate (e.g., swinging,



sliding), dimensions, and method of operation (manual, electric) must also be provided. Note or identify the following on the fire access plan:

- A. Clear Width – Gated openings for egress and ingress of vehicles shall not be less than 13 feet clear width. The vertical clearance shall not be less than 13 feet 6 inches, including landscaping and/or trees. This reduction in width is applicable only to the area immediately adjacent to the guard house or gate. Roads leading up to and beyond the guard house or gate shall meet standard fire lane width requirements prescribed in Section 2.A.5 of this guideline. See Attachment 4.
- B. Turning Radii - The minimum inside turning radius is 31 feet with an outside radius of 42 feet for both the exterior and the interior approach to the gate.
- C. Setbacks from the Street - Gates and barriers shall be located a minimum of 46 feet (for existing developments) and 56 feet (for new developments) from any major street. A private driveway serving only one single-family residence is exempt from this requirement. If existing conditions prevent installation of the minimum setback, documentation supporting an acceptable alternative shall be provided. The alternative solution must facilitate emergency ingress without endangering emergency response personnel, emergency apparatus, and the general public. The alternative shall be subject to review and approval. See Attachment 15.
- D. Setbacks from First Interior Turn - A 27-foot minimum unobstructed setback is required from a gate to the first turn to allow emergency apparatus clearance. See Attachment 15.
- E. Manually Operated Gate and Barrier Design - Typical gate designs may include sliding gates, swinging gates or arms, or guard posts with a chain traversing the opening.
  - 1) Permanent or removable bollards are not permitted to be placed across fire access roadways. CFC 503.4
  - 2) For gates and barriers that are not used on a frequent basis or those that are located such that they have a reasonable likelihood of being blocked by vehicles, vegetation, furniture, or other obstructions (e.g., secondary fire department vehicle ingress/egress points, gates accessed from plazas or turf block areas), permanent signage constructed of 18-gauge steel or equivalent shall be attached on each face of the gate or barrier that reads “FIRE LANE—NO PARKING.” See Attachment 16 for an example of a barrier sign.
  - 3) Manually operated gates and barriers shall have frangible padlocks, Knox padlocks, or weather-resistant Knox key boxes. The key box shall be placed four to five feet above the roadway surface at the right side of the access gate

in a conspicuous location that is readily visible and accessible. The key box must be clearly labeled "FIRE DEPT." CFC 506

F. Electrically Operated Gates and Barriers

- 1) In the event of loss of normal power to the gate operating mechanism, it shall be automatically transferred to a fail-safe mode allowing the gate to be pushed open by a single firefighter without any other actions, knowledge, or manipulation of the operating mechanism being necessary and without the use of battery back-up power; this shall be noted on the plan. The manufacturer's specification sheet demonstrating compliance with this method of operation during power loss shall be provided or scanned directly onto the plan. Should the gate be too large or heavy for a single firefighter to open manually, a secondary source of power by means of an emergency generator or a capacitor with enough reserve to automatically and immediately open the gate upon loss of primary power shall be provided.
- 2) The gate control for electronic gates shall be operable by a Knox emergency override key switch (with dust cover). The key switch shall be placed between 42" and 48" above the roadway surface at the right side of the access gate within two feet of the edge of the roadway. The key switch shall be readily visible and unobstructed from the fire lane leading to the gate. The key switch shall be clearly labeled "FIRE DEPT."
- 3) Upon activation of the key switch, the gate shall open and remain open until returned to normal operation by means of the key switch. Where a gate consists of two leaves, the key switch shall open both simultaneously if operation of a single leaf on the ingress side does not provide for the width, turning radii, or setbacks necessary for fire apparatus to navigate the vehicle entry point. Note this requirement on the plan.
- 4) The key switch shall be labeled with a permanent red sign with not less than 1/2" contrasting letters reading "FIRE DEPT" or with a "Knox" decal. Note this requirement on the plan.

G. Gate and Barrier Locks - Gate or barrier locks shall be reviewed and approved prior to their installation on any new and/or existing access gate or barrier.

**6. Requirements for Residential Tract Developments**

The following requirements apply to all new residential tract developments with single-family homes or duplexes. They may also be applied to individual single-family homes or duplexes or to multi-family housing projects as approved by the fire code official.

A. Cul-de-sacs. See Attachment 17.

- 1) Any street that is a required fire lane and greater than 150 feet in length shall be provided with a 45-foot minimum turning radius or other approved turnaround within 150' of the end of the fire lane. See Attachment 17.
  - 2) The cul-de-sac "bulb" (the portion at the end of the cul-de-sac street which is wider than the cul-de-sac "neck" leading to it) shall be identified as a fire lane with red curbs or "Fire Lane—No Parking" signs. Fire lane markings may be omitted from the bulb if one or more of the following applies:
    - a. A three-point turn may be made within 150' of the end of the cul-de-sac with all areas along the curb assumed to be occupied by parked vehicles. Auto-Turn software or other approved methods shall be used to demonstrate this. See Attachment 7; or
    - b. The length of the cul-de-sac street, including any driveway or spur road accessed from the bulb that is a required fire lane, is not more than 150 feet; or
    - c. The radius of the cul-de-sac is at least 53 feet; or
    - d. The cul-de-sac is a public street and local traffic or planning restrictions prohibit the designation of fire lanes in the bulb:
      - i. The homes accessed from the bulb of the cul-de-sac shall be protected with an automatic fire sprinkler system complying with NFPA 13-D. The sprinkler system shall include full protection of the attic space(s).
      - ii. Written concurrence shall be provided from the city traffic engineer indicating that such a prohibition on fire lane signs or red curbs is consistent with local zoning, development, and traffic codes.
- B. Since local law enforcement resources are limited for enforcement purposes in private developments, the City of Perris requires a viable parking enforcement plan from the developer prior to approving the fire department access & water plan. Parking enforcement plans shall include:
- 1) Detailed information specifically identifying who will be responsible for enforcing the plan, and
  - 2) Powers granted to the entity shall include vehicle towing for parking violations (include language similar to that provided in Attachment 8 of this guideline), and
  - 3) The level of enforcement to be carried out within the development.

This information must be integrated into the fire access plan. Evidence that the enforcement plan is permanently incorporated into the Conditions, Covenants, and Restrictions (CCRs) and/or recorded against the deed shall be provided prior to Perris approval of the final map or print of linen. Once approved, these provisions cannot be amended without written approval by the Perris Fire Department, City of Perris. See Attachment 18 for a sample enforcement letter.

## 7. Engineered Alternative Fire Apparatus Access Systems

The use of Turf Block, Grasscrete, or similar products are not permitted in the City of Perris.

## 8. Hydrant and Water Availability Requirements

Applicants must provide documentation that hydrants are provided in the quantity and spacing described in California Fire Code (CFC) Appendix C. This will prove that they are capable of delivering the amount of water required by CFC Appendix B. The quantity and spacing of hydrants is governed by the fire flow required for the structure(s) served. The required fire flow is dependent upon the size of the structure, type of construction, and whether the building is equipped with fire sprinklers. This information must be shown clearly on the plans to assist in the determination of the fire flow requirement.

A. Water Availability – To facilitate the review process and avoid untimely delays in project approval, applicants are strongly encouraged to arrange a hydrant flow test with the water company *prior to submitting plans to the Perris* if the project includes a new structure or increase in the floor area of an existing structure. Water availability information may not be required to be submitted for every project, and plans may be submitted with a hydrant flow test pending, but the applicant should understand that project approval may be delayed if it is determined during review that this information is required. If the project requires evaluation of the available fire flow, it will not be approved without a completed Perris Water Availability form or equivalent data sheets from a water district. Water availability information must be no older than twelve months.

- 1) Obtain a Water Availability form from Perris Building Department.
- 2) Fill out the project and building information in the first section of the Water Availability form. Care should be taken when determining the applicable fire area for the project. As stated above, fire flow is dependent on several factors, so *the largest building or group of structures is not necessarily the most demanding* in terms of fire flow.
- 3) Determine the required fire flow from CFC Table B105.1, provided in Attachment 19. A **maximum 50%** reduction in fire flow (but not duration) may be taken when the fire-flow calculation area consists only of buildings equipped

with an approved automatic fire sprinkler system. The fire flow shall not be less than 1500 GPM for commercial buildings and 750 for sprinklered residential units less than 3,600 ft<sup>2</sup>.

4) Contact the Monte Vista Water District to request a hydrant flow test or fire flow modeling calculation, and have a representative of the water company complete and sign the last section on the form. In some cases, the water company may allow or require a qualified third party to perform the flow test for you.

a) In newly developed areas without water infrastructure, the water department may issue a “will-serve” letter indicating the expected amount of water that will be delivered once the water system is installed and operational.

b) If multiple hydrants are located within the maximum distance allowed by CFC Table C102.1, the amount of water available from each hydrant may be combined, provided that the hydrants are flowed simultaneously.

c) It is the applicant’s responsibility to ensure that the following information is provided at a minimum on either the water company’s test data sheet and/or the Perris Water Availability form:

(a) Static pressure and residual pressure in psi and observed flow in gpm;  
or

(b) Calculated flow in gpm at 20 psi.

d) Scan or photocopy the completed form or data sheets onto your plans or include the original with your plan submittal.

5) Please ensure that the fire area, building size, construction type, and flow data are complete and accurate. Errors or omissions in this information may result in plans having to be resubmitted or fire flow testing being redone.

B. Fire-Flow Calculation Area – The fire-flow calculation area shall be the total floor area of all floor levels within the exterior walls, and under the horizontal projections of the roof of a building, except as modified in Section B104.3. Portions of buildings which are separated by fire walls without openings, constructed in accordance with the California Building Code are allowed to be considered as separate fire-flow calculation areas. The fire-flow calculation area of buildings constructed of Type IA and Type IB construction shall be the area of the three largest successive floors. CFC Appendix B Section B104

C. Hydrant Location – Hydrants shall be provided along the length of the fire access roadway in the quantities based on fire flow specified in Table C102.1 and up to

the maximum distances of 300 feet. Note: Table C102.1 is used for minimum number of hydrant only, the average hydrant spacing and maximum distance columns in the table are superseded by local amendment.

- 1) Hydrants must be located no more than three feet from the edge of a fire access roadway and cannot be located in areas where they will be visually or operationally obstructed (behind fences or walls, in bushes, behind parking spaces, etc.). Clearance shall be provided to a distance no less than three feet from the perimeter of the hydrant. Where hydrants are located in landscaped areas, a 4x4' concrete pad shall be required to ensure that vegetation does not encroach on this clear space.
- 2) The hydrant outlets must face the fire access roadway. Where all of the outlets cannot face the fire access roadway (e.g., the hydrant is located in a landscape peninsula or island in a parking lot; the hydrant has three outlets), the 4" outlet(s) shall take precedence.
- 3) The hydrant shall be located at least 40 feet from the building(s) it serves. Where it is impractical to locate the hydrant 40 feet from adjacent structures, hydrant spacing shall be reduced by 50%. Fire hydrant may be located closer provided that nearby walls do not contain openings and the hydrant is not otherwise located where it can be rendered inoperable due to damage from collapsed walls, debris, or excessive heat.
- 4) Hydrants shall be located so that a hose line running between the hydrant and the fire department connection(s) (FDCs) served by that hydrant does not cross driveways, obstruct roads or fire lanes, or otherwise interfere with emergency vehicle response and evacuation of a site.
- 5) Hydrants and fire department connections shall not be located behind parking stalls or in other locations where they are likely to be blocked by vehicles or other objects. Whenever possible, hydrants shall be placed at street and drive aisle intersections in preference to mid-block locations. Where on-street parking is allowed, hydrants should be placed in the shortest parkways between adjacent driveways, at corners and chokers where parking is not normally allowed, and in similar areas where impact to space available for parking and the potential for hydrants to be obstructed is minimized.
- 6) Hydrants and fire department connections should not be located where apparatus staged at these appurtenances would then encroach on minimum fire apparatus turning radii unless alternative routes are available. Hydrants shall not be placed in the "bulb" end of a cul-de-sac where apparatus staged at the hydrant would prevent the cul-de-sac from being used as a turnaround.

D. Protection of Hydrants – Where hydrants are located such that they are exposed to potential damage from vehicular collision, they shall be protected by curbs or bollards. See Attachment 21.

- 1) If vehicles can approach the hydrant from more than one direction, the hydrant shall be protected by four bollards of concrete-filled pipe four inches in diameter and mounted in concrete in a square around the hydrant. The bollards need to be spaced a minimum of three feet from the perimeter of the hydrant. The bollards must be placed so that their location does not impede access to or use of the hydrant. Two bollards may protect hydrants that can be approached from only one side. Bollard installation requirement can be located in the CFC § 312.2.
- 2) Hydrants may not require protection by bollards if they are located such that the potential for collision is minimal or if they are sufficiently protected by a standard concrete curb at least six inches in height.

E. Hydrant Markers and Color –

1. Blue reflective pavement markers (“blue dots”) shall be used to identify fire hydrant locations. Blue reflective markers used for any other purpose should be removed. See Attachment 22.
  - a) Two-way streets and roads – Markers shall be placed six inches from the edge of the painted centerline or from the approximate center of streets without a painted centerline on the side nearest the hydrant.
  - b) Streets with left turn lanes at the intersection – Markers shall be placed six inches from the edge of the painted white line on the side nearest the hydrant.
  - c) Streets with continuous two-way left turn lane – Markers shall be placed six inches from the edge of the painted yellow line on the side nearest the fire hydrant.
2. Hydrant Color
  - a) Private hydrants (hydrants separated from the city main by and located downstream from a backflow prevention device) shall be painted OSHA safety red or equivalent. A plan for underground piping serving private hydrants shall be submitted to the City of Perris for review and approval.
  - b) Public hydrants shall be painted any color other than red as specified by the local water purveyor or city water department.

## 9. Access to Structures

- A. Hose pull – The dimension of 150 feet when used in relation to fire department access is commonly referred to as “hose pull distance.” As the name implies, this is the maximum distance that firefighters can effectively pull a fire hose or carry other equipment to combat a fire. The hose pull distance is set at 150 feet due to a variety of factors, including standard hose lengths, weight of equipment, hydraulic properties, and accepted operational procedures. See Attachments 23.
- 1) Hose pull is measured along a path that simulates the route a firefighter may take to access all portions of the exterior of a structure from the nearest public road or fire lane. Under most circumstances, hose pull will not be a straight-line distance and should *not* be measured “as the crow flies.”
  - 2) All obstructions such as fences, planters, vegetation, and other structures must be considered when determining whether a building is accessible from a particular location on the fire access roadway. Topography may also affect the potential access route and any significant changes in elevation must be accounted for when measuring hose pull distances.
  - 3) Hose pull measurements begin at a point in the street located 10 feet from the edge of the curb.
- B. Access walkways - CFC 504.1 specifies the installation of approved access walkways from fire access roadways to exterior openings required by either the CBC or CFC. The City of Perris may require the construction of such walkways depending upon particular site conditions or project parameters. These conditions include, but are not limited to, building use or occupancy, topography, vegetation, and surface conditions. Design professionals must carefully consider these issues when developing a project site.
- 1) Access walkways must be provided to all required egress doors from a building, all firefighter access doorways in buildings with high-piled storage, and the area beneath each rescue window in “R” occupancies, at a minimum. Access walkways will typically be required around the entire perimeter of a structure to facilitate control of a fire through any other available openings.
  - 2) Access walkways must be a minimum of five feet in width.
  - 3) Access walkways shall consist of a surface that lends itself to safe use during building evacuation, firefighting, and rescue efforts. Solid surface walkways such as concrete or asphalt are preferable, though alternative surfaces such as decomposed granite (DG), gravel, or grass are permissible under certain conditions. Ground covers and shrubs that prevent or impede laddering of structures are not permitted to be planted on or adjacent to access walkways.



- 4) Where the grade itself presents a slip or fall hazard, an access walkway with a slip-resistant surface and/or stairway must be provided.
  - 5) The type of material provided for the access walkway and/or other specifications shall be indicated on the fire access plan and are subject to approval by the Perris.
- C. Path of travel obstructions - Firefighter access to and emergency egress from required openings must remain free and unobstructed at all times. Architects, landscape designers, and facility managers must take care to ensure that fences, planters, and vegetation will not interfere with access and egress routes.
- 1) Fences - Walls, fences, hedges, and similar obstructions may not be located within the area designated as an access walkway unless a gate through the obstruction equipped with an approved padlock or Knox box has been provided for firefighters to access the perimeter of the structure. If the wall or fence blocks travel from required egress openings to the public way or an open area at least 50 feet from the structure ("Access to a public way" per CBC 1028.5), a gate operable by the occupants evacuating the structure must be provided that allows unimpeded egress to the public way. Where doors in the path of emergency egress travel are required to be equipped with panic hardware, gates shall likewise be similarly equipped. These requirements may not apply to individual single family residences.
  - 2) Vegetation - As stated previously, certain types of ground cover and low-growing plants present an impediment to firefighting and rescue operations and are prohibited from being planted in the access walkway. In addition, taller vegetation such as shrubs and trees may not be located where they will, either when planted or upon maturation, present an obstruction to accessing rescue windows. Raised planter areas are not allowed to be used as rescue ladder access points.
  - 3) Key boxes and key switches - Knox devices shall be provided where necessary to ensure that immediate access for firefighting, rescue, and other emergency purposes is possible.
    - a) Location - At a minimum, Knox devices shall be provided for the following locations:
      - gates along the paths of firefighter travel from the fire lane to all points along the perimeter of the structure;
      - gates to pool enclosures;
      - building gates or doors leading to interior courtyards containing rescue windows;
      - building gates or doors leading to exterior hallways providing access to residential units or tenant suites;

- gates in exterior enclosures containing hazardous or combustible material storage;
- exterior doors to rooms containing main alarm panels or annunciators;
- doors and gates providing access to parking structures;
- doors and gates to other areas identified by the fire department.

When approved by the OFM, a frangible padlock or chain that can be cut with bolt cutters or a Knox padlock may be used in lieu of a key box for exterior hazardous or combustible materials storage areas. Manually operated vehicle or pedestrian access gates that are not commonly used or required to be openable from the egress side may also be provided with a frangible padlock or chain.

Knox boxes or switches shall be located adjacent to and clearly visible from the gate or door served. They shall be securely mounted to a wall or fence at a height of four to five feet above grade in a location that is easily accessible to firefighters and, when required, police officers. Where the potential for vandalism or tampering is significant, key boxes that are not submastered for police department use may be mounted higher than five feet with Perris approval. Boxes and switches are not required to be electronically monitored; if they are, they shall not initiate an alarm signal that requires a response by the fire department.

- b) Key box contents - The key used to unlock the gate or door shall be kept in the key box. When the key unlocks more than the individual adjacent gate or door, a label or tag shall be attached to the key identifying the gates or doors it operates. Where multiple gates or doors are served by a single box, two or more copies of the key(s) are recommended so that a copy will be available to each engine company responding to the site.
- c) Electric locks – Electromagnetically or electromechanically locked pedestrian gates and doors shall be equipped either with a Knox box containing a key to open the lock or, if the door lock cannot be operated with a key from the exterior, a Knox key switch shall be provided adjacent to the door. Where key switches are provided, the door or gate lock shall remain disengaged until the key switch is returned to the “normal” closed or locked position.
- d) Vehicle gates - See sections 5.E through 5.G for more information on requirements for Knox boxes and key switches serving vehicle gates across fire lanes.

## **10. Access during construction**

Access and water supply during construction shall comply with CFC Chapter 33 and the provisions listed in this section and, where applicable, elsewhere in this guideline. Construction activities at job sites not complying with these requirements may be suspended at the discretion of the Perris inspector until a reasonable level of compliance is achieved.

At no time shall construction projects impair or obstruct existing fire access roadways or access to and operation of existing fire hydrants serving other structures. Should existing roadways or hydrants need to be moved or otherwise altered during the course of construction, the developer shall provide alternative access routes and other mitigation features to ensure adequate fire and life-safety protection. Such alternatives and features shall be submitted to the Perris for review and approval prior to alteration of existing conditions.

- A. Lumber drop inspection – an inspection shall be scheduled with a OFM inspector to verify that access roadways and operable hydrants have been provided for buildings under construction.
- 1) For buildings of Type IV and V construction (and non-combustible structures that may have a portion of the exterior walls, façade, or other building elements comprised of wood or other combustible material), a lumber drop inspection shall occur prior to bringing combustible building materials on site.
  - 2) For other construction types (Type I, II, III) with exterior walls built of non-combustible materials, an inspection shall occur prior to commencing interior construction involving combustible materials (e.g., wooden mezzanines or partition walls, carpet, cabinetry or other woodwork, furniture, etc.) or prior to the installation of a combustible roof structure.
  - 3) An inspection shall occur prior to construction reaching 40 feet in height for buildings of any construction type that will have four or more floors when complete.
  - 4) The street address of the site shall be prominently posted at each entrance. For projects on streets that do not have a name or street signs posted yet, the sign shall include the project name and tract/lot number.
  - 5) Gates through construction fencing shall be equipped with a Knox padlock or frangible lock/chain.
  - 6) When required by the Perris Fire Inspector, fire lanes shall be posted with “Fire Lane—No Parking” signs or no parking areas shall be otherwise identified to maintain them free of obstructions during construction.
  - 7) Provisions shall be made to ensure that hydrants are not blocked by vehicles or obstructed by construction material or debris. A three-foot clear space shall

be provided around the perimeter of the hydrant and no parking or similar obstructions shall be allowed along the adjacent road within 15 feet of the hydrant. Inoperable hydrants shall be bagged.

B. Temporary Fire Access Roads - Temporary access roads (construction roads that do not match the final location and configuration of permanent roads as approved on a Fire Access Plan) and temporary hydrants may be permitted for *single family residential model construction or a single detached custom home less than 3,600 square feet in area* with the following conditions:

- 1) Plans for temporary access shall be submitted to the Perris Fire Prevention Bureau via Building Department, City of Perris. Plans shall be drawn to scale and show permanent (existing) roadways, proposed temporary roadway locations, location of models, space dedicated to storage of construction materials, and parking for work crews and construction vehicles. The plans shall clearly state that they have been submitted for temporary access and hydrants.
- 2) Plans shall be stamped and signed by a licensed civil engineer stating that the temporary access road can support 75,000 pounds of vehicle weight in all-weather conditions. The road base material shall be over soil compacted to at least 90% and be mixed or topped with a suitable binding material to provide all-weather characteristics; road base alone does not satisfy this requirement.
- 3) Provide a parking plan for the construction site detailing how the fire lane no parking regulations will be enforced. Include a clause in the letter stating that “the job-site superintendent is responsible for informing the work crews of parking requirements and that the entire job-site is subject to shut-down by the OFM inspector if parking is in violation of fire lane posting.” The letter shall be written on company letterhead and scanned onto the plan.
- 4) Aboveground invasion lines are acceptable for water supply.
  - a) Provide detail drawings detailing how the line will be secured in place and protected from vehicular damage.
  - b) An invasion line may be run underground if the depth of bury can support the 75,000-pound weight of a fire apparatus.
  - c) The temporary water line must provide the required fire flow; calculations are required.
  - d) The pipe shall be listed for fire service.
  - e) Fire hydrants shall consist of a minimum 6” barrel with one 2-1/2” outlet and a 4” outlet. Note this on the plan.

- 5) All other access and water requirements shall apply (e.g., width, approach clearance, premises identification, locks, gates, barriers, etc.).
- 6) The approved plan for temporary access and water supply shall be available at the construction site prior to bringing combustible building materials on-site.
- 7) An inspection by OFM Inspector is required to verify adherence to the approved plan prior to bringing combustible materials on-site.

C. Phased access - Incremental installation of permanent access roadways as shown on a fire master plan may be permissible for commercial and residential developments. If phased installation is anticipated, the site superintendent or designee shall review the installation process with a Perris inspector during the lumber drop inspection or pre-construction meeting. Depending on the complexity of the installation, size of the project, and other project-specific factors, the inspector may allow phased installation to proceed immediately or may first require that all or some of the following items are satisfied:

- 1) Plans for phased access shall be submitted to the Perris Fire Prevention Bureau via Building Department, either as part of the original access plan submittal or as a revision to an approved fire access plan. Plans shall be drawn to scale and demonstrate that all access and water requirements are met during all phases of construction and that approval of one phase does not compromise or complicate completion of the subsequent phases. Plans shall show for each phase of construction:
  - The extent of building construction
  - Location of operable hydrants serving all buildings under construction
  - The location of construction fencing, barriers, and vehicle access gates
  - The location of all temporary or permanent "Fire Lane—No Parking" signs
  - Equipment/materiel staging locations
  - Worker parking areas (see item "4" below)
- 2) Phasing plans shall be stamped and signed by a licensed civil engineer stating that the access road can support 75,000 pounds of vehicle weight in all-weather conditions. The road base material shall be over soil compacted to at least 90% and be mixed or topped with a suitable binding material to provide all-weather characteristics; road base alone does not satisfy this requirement. The final road section less the final lift of asphalt topping may be acceptable if certified by the engineer.
- 3) The phasing plan shall identify any anticipated areas where fire department access roadways may be temporarily inaccessible due to trenching, slurry coating, striping, or other construction activities after they have been installed and inspected. The plan shall indicate the anticipated period of impairment

and include provisions for providing plating over trenches and alternative access routes, notification to the fire department, and/or other forms of mitigation when such roadways are impaired.

- 4) Provide a parking plan for the construction site detailing how the fire lane no parking regulations will be enforced. Include a clause stating that “the job-site superintendent is responsible for informing the work crews of parking requirements and that the entire job-site is subject to shutdown by the OFM Inspector if parking is in violation of fire lane posting.”
- 5) The approved phasing plan shall be available at the construction site prior to bringing combustible building materials on-site. A lumber drop inspection by a OFM Inspector will be required prior to the commencement of each phase.
- 6) All other access and water requirements shall apply (e.g., width, approach clearance, premises identification, locks, gates, barriers, etc.).

---

## INDEX OF ATTACHMENTS

<b>NUMBER:</b>	<b>SUBJECT .....</b>	<b>PAGE</b>
1:	Standard Fire Master Plan Notes .....	24
2:	Fire Master Plan Submittal Checklist .....	26
3:	Minimum Road Widths .....	27
4:	Clearance for Typical Gated Community Guard House .....	28
5:	Fire Apparatus Access Roadway Clearance .....	29
6:	“S” Curves .....	30
7:	Minimum Turnaround and Hammerhead Dimensions.....	31
8:	Fire Lane Parking Violations.....	33
9:	Red Curb Specifications.....	34
10:	Fire Lane Entrance Sign Specifications.....	35
11:	Alternative Location for Towing Company Information.....	36
12:	Fire Lane No Parking Sign Specifications .....	37
12a:	Cul-de-Sac Fire Lane No Parking Sign Specifications .....	38
12b:	Alternative Fire Lane No Parking Sign Specifications .....	39
13:	Fire Lane No Parking Sign Locations .....	40
13a:	Fire Lane No Parking Sign Locations for Cul-de-sacs .....	41
14:	Sign Mounting Specifications.....	42
15:	Minimum Gate Setbacks.....	43
16:	Fire Lane No Parking Signs for Gates and Barriers .....	44
17:	Short Cul-de-sacs and Dead-end Roadways.....	45
18:	Sample Parking Enforcement Letter .....	46
19:	Fire Flow Table .....	47
20:	Hydrant Quantity and Spacing Table .....	48
21:	Protection of Hydrants, Detector Checks, FDCs, and other Appurtenances .	49
22:	Blue Dot Hydrant Marker Location .....	50
23:	Hose Pull.....	51

# ATTACHMENT 1

## Perris Fire Department Access & Water Plan Notes

All of the notes listed in the INSPECTION REQUIREMENTS and GENERAL REQUIREMENTS sections shall be placed, verbatim, on the plan under the heading "FIRE DEPARTMENT ACCESS & WATER NOTES."

### INSPECTION REQUIREMENTS

1. Perris site inspections are required for this project. Please schedule all field inspections at least 48 hours in advance. Inspections canceled after 1 p.m. on the day before the scheduled date will be subject to a re-inspection fee. Call (951) 443-1029 to schedule an inspection.
2. A lumber drop inspection shall be performed prior to bringing combustible materials (or combustible fixtures and finishes for structures of non-combustible construction). All-weather access roads capable of supporting 75,000 lbs., topped with asphalt, concrete, or equivalent shall be in place and hydrants operational at time of lumber drop inspection.
3. For projects with fuel modification, a vegetation clearance inspection is required prior to a lumber drop inspection. Use the fuel modification plan service request number to schedule the vegetation clearance inspection.
4. Phased installation of fire access roads requires additional inspections not covered by the fees paid at plan submittal. Call OFM (951) 443-1029 to schedule inspection to arrange for additional inspections that may be needed and any fees that may be due.
5. An original approved, signed, wet-stamped Perris fire access & water plan shall be available on-site at time of inspection.
6. Access roads and hydrants shall be maintained and remain clear of obstructions at all times during and after construction. Areas where parking is not permitted shall be clearly identified at all times. Obstruction of fire lanes and hydrants may result in cancellation or suspension of inspections.
7. Temporary fuel tanks of 60 or more gallons shall be reviewed, inspected, and permitted by the Perris Fire Department, City of Perris prior to use.
8. The project address shall be clearly posted and visible from the public road during construction.
9. All gates in construction fencing shall be equipped with either a Knox or breakaway padlock.
10. Buildings of four or more stories shall be provided with stairs and a standpipe before reaching 40 feet in height.

### GENERAL REQUIREMENTS

11. Fire lane widths shall be measured from top face of the curb to top face of the curb for fire lanes with standard curbs and gutters and from flow-line to flow-line for fire lanes with modified curb designs (e.g., rolled, ramped, etc.). The developer is responsible to verify that all approved public works or grading department street improvement plans or precise grading plans conform to the minimum street width measurements per the approved Perris fire department access & water plan and standards identified in Perris Fire Prevention Bureau Access & Water Guideline for all portions of the fire access roads.
12. Permanent, temporary, and phased emergency access roads shall be designed and maintained to support an imposed load of 75,000 lbs. and surfaced to provide all-weather driving capabilities.
13. Fire lane signs and red curbs shall meet the specifications shown in Perris Fire Prevention Bureau Access & Water Guideline and shall be installed as described therein. Additional fire lane markings may be required at the time of inspection depending on field conditions.
14. All fire hydrants shall have a "Blue Reflective Pavement Marker" indicating their location per the Perris standard. On private property markers are to be maintained in good condition by the property owner.
15. Address numbers shall be located and be of a color and size so as to be plainly visible and legible from the roadway from which the building is addressed in accordance with Perris Fire Prevention Bureau Access & Water Guideline.
16. Access gates shall be approved prior to installation and shall be in compliance with Chapter 5 of the CFC and Perris Prevention Bureau Access & Water Guideline.
17. Approved access walkways shall be provided to all required openings and all rescue windows.



18. Vegetation shall be selected and maintained in such a manner as to allow immediate access to all hydrants, valves, fire department connections, pull stations, extinguishers, sprinkler risers, alarm control panels, rescue windows, and other devices or areas used for firefighting purposes. Vegetation or building features shall not obstruct address numbers or inhibit the functioning of alarm bells, horns, or strobes.
19. Dumpsters and trash containers larger than 1.5 cubic yards shall not be stored in buildings or placed within 5 feet of combustible walls, openings or combustible roof eave lines unless protected by an approved sprinkler system.
20. Any future modification to the approved Fire Prevention Bureau Access & Water Plan or approved site plan, including but not limited to road width, grade, speed humps, turning radii, gates or other obstructions, shall require review, inspection, and approval by the Perris Fire Department, City of Perris.
21. Approval of this plan shall not be construed as approval of any information or project conditions other than those items and requirements identified in Perris Fire Prevention Bureau Access & Water Guideline and related portions of the CFC and CBC. This project may be subject to additional requirements not stated herein upon examination of actual site and project conditions or disclosure of additional information.

---

## ATTACHMENT 2

### Fire Prevention Bureau Access & Water Plan Submittal Checklist

#### PROJECT INFORMATION

---

- |   |                              |  |
|---|------------------------------|--|
| Scope of project is clearly defined on the plan?                  | <input type="checkbox"/> Yes |  |
| Conditional Use Permit conditions included with submittal?        | <input type="checkbox"/> Yes | <input type="checkbox"/> N/A (CUP was not required by city)              |
| Tract/Tentative Tract/Parcel Map Number has been provided?        | <input type="checkbox"/> Yes |  |
| Standard Perris fire master plan notes are included?              | <input type="checkbox"/> Yes |  |
| Building area, construction, occupancy, sprinklers noted on plan? | <input type="checkbox"/> Yes |  |
| Allowable area calculation provided on plan?                      | <input type="checkbox"/> Yes | <input type="checkbox"/> N/A (Building less than 6000 sq.ft.)            |
| AM&M request letter scanned onto plan?                            | <input type="checkbox"/> Yes | <input type="checkbox"/> N/A (No alternate methods proposed)             |
| Sheets not relevant to fire master plan removed from plan set?    | <input type="checkbox"/> Yes |  |
| Access/hydrant phasing plan provided?                             | <input type="checkbox"/> Yes | <input type="checkbox"/> N/A (No phasing of access/hydrant installation) |

#### WATER AND HYDRANTS

---

- |   |                              |                             |
|---|------------------------------|-----------------------------|
| Water availability form completed and provided?         | <input type="checkbox"/> Yes | <input type="checkbox"/> No |
| All hydrants within 400' of the site are shown on plan? | <input type="checkbox"/> Yes |                             |
| Are hydrants provided/spaced per CFC Appendix C?        | <input type="checkbox"/> Yes |                             |

#### ACCESS AND ROADWAYS

---

- |  |                              |  |
|--|------------------------------|--|
| Extent of the access roadway is clearly shown on the plan?       | <input type="checkbox"/> Yes |  |
| Turning radii and width (incl. road sections) shown on the plan? | <input type="checkbox"/> Yes |  |
| Exterior of all structures within 150' hose pull distance?       | <input type="checkbox"/> Yes | <input type="checkbox"/> No (Mitigation proposed via AM&M) |
| Engineer's certification provided for new paving?                | <input type="checkbox"/> Yes | <input type="checkbox"/> N/A (No new paving)               |
| Walkable surface provided to required openings?                  | <input type="checkbox"/> Yes |  |
| Road and walkway grades >10% (7% in Irvine) shown on plan?       | <input type="checkbox"/> Yes | <input type="checkbox"/> N/A (Grade <10%, <7% in Irvine)   |

#### FIRE LANE IDENTIFICATION

---

- |   |                              |   |
|---|------------------------------|---|
| Red curbs are identified with bold or dashed lines?             | <input type="checkbox"/> Yes | <input type="checkbox"/> N/A (Signs provided)     |
| Location of each "Fire Lane—No Parking" sign shown?             | <input type="checkbox"/> Yes | <input type="checkbox"/> N/A (Red curbs provided) |
| Fire lane entrance sign provided at each vehicle entrance?      | <input type="checkbox"/> Yes |   |
| Detail drawings of red curbs/"No Parking"/entrance signs shown? | <input type="checkbox"/> Yes |   |

#### GATES AND OBSTRUCTIONS

---

- |   |                              |  |
|---|------------------------------|--|
| Are all gates, fences, and planters shown?          | <input type="checkbox"/> Yes |  |
| Are vehicle gates identified as manual or electric? | <input type="checkbox"/> Yes | <input type="checkbox"/> N/A (No gates)        |
| Manual vehicle gates have "No Parking" sign noted?  | <input type="checkbox"/> Yes | <input type="checkbox"/> N/A (No manual gates) |
| Knox boxes/locks/switches are noted on plans?       | <input type="checkbox"/> Yes | <input type="checkbox"/> N/A (No gates)        |
| Perris gate notes/specifications included on plan?  | <input type="checkbox"/> Yes | <input type="checkbox"/> N/A (No gates)        |
| Knox form completed?                                | <input type="checkbox"/> Yes | <input type="checkbox"/> N/A (No gates)        |

#### OTHER REQUIREMENTS

---

- |  |                              |  |
|--|------------------------------|--|
| Premises ID/address monument location shown on plan?     | <input type="checkbox"/> Yes | <input type="checkbox"/> N/A (Single family homes)       |
| Trash enclosures are located at least 5' from buildings? | <input type="checkbox"/> Yes | <input type="checkbox"/> No (Enclosures are sprinklered) |
| Two entry points provided for 150 or more residences?    | <input type="checkbox"/> Yes | <input type="checkbox"/> N/A (Non-residential project)   |
| Parking enforcement letter provided?                     | <input type="checkbox"/> Yes | <input type="checkbox"/> N/A (Public streets only)       |

*NOTE: This is only a listing of basic fire master plan submittal requirements. Other information or requirements may be necessary depending on conditions specific to each project.*

## ATTACHMENT 3

### Minimum Road Widths

Measured from top face of curb to top face of curb for standard vertical curbs or flow line to flow line for rolled, ramped, or other curb types.

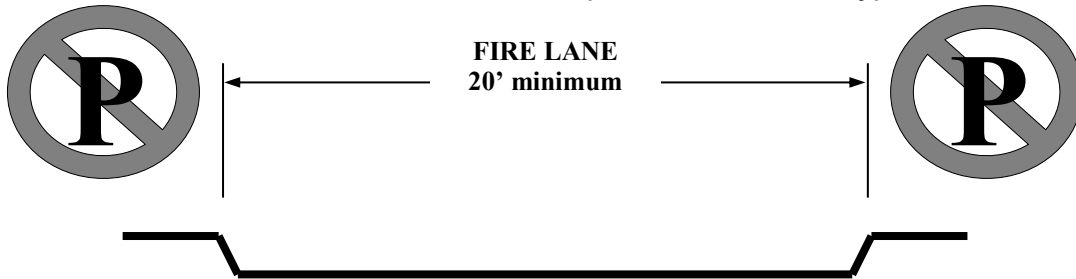

**ROADWAY LESS THAN 28'**  
*Parking prohibited.*  
*Roadway is required to be posted as a fire lane.*

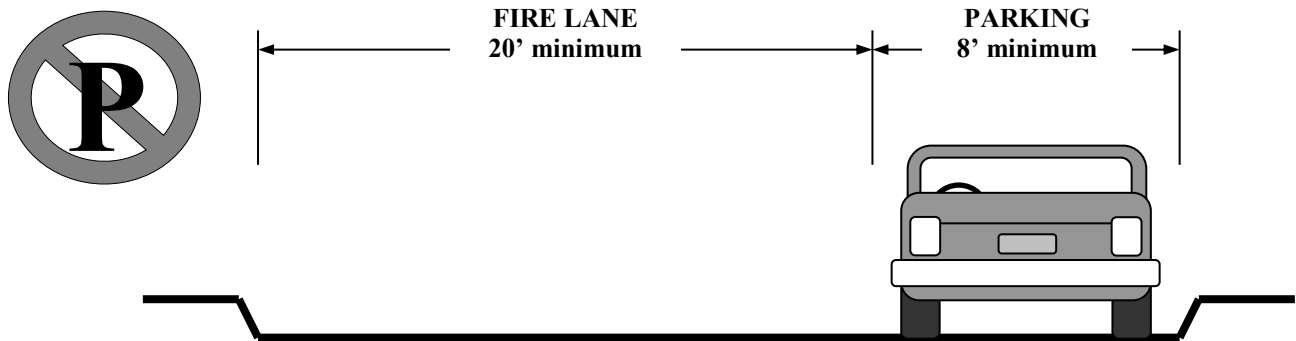

**ROADWAY AT LEAST 28' BUT LESS THAN 36'**  
*Parking permitted on one side only.*  
*Roadway is required to be posted as a fire lane.*

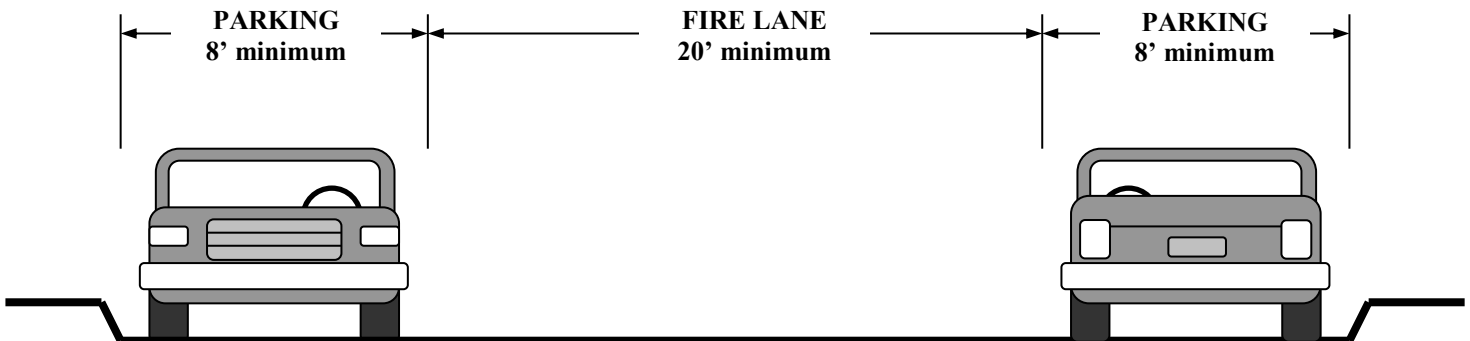

**ROADWAY 36' OR WIDER**  
*Parking permitted on both sides*

## ATTACHMENT 4

### Fire Apparatus Access Roadway Clearance For Typical Gated Community Guard House

*Fire lane width reductions detailed below are applicable only to the area immediately adjacent to the guard house or gate. Roads leading up to and beyond the guard house or gate shall meet standard fire lane width requirements prescribed in Section 2.A.5 of this guideline.*

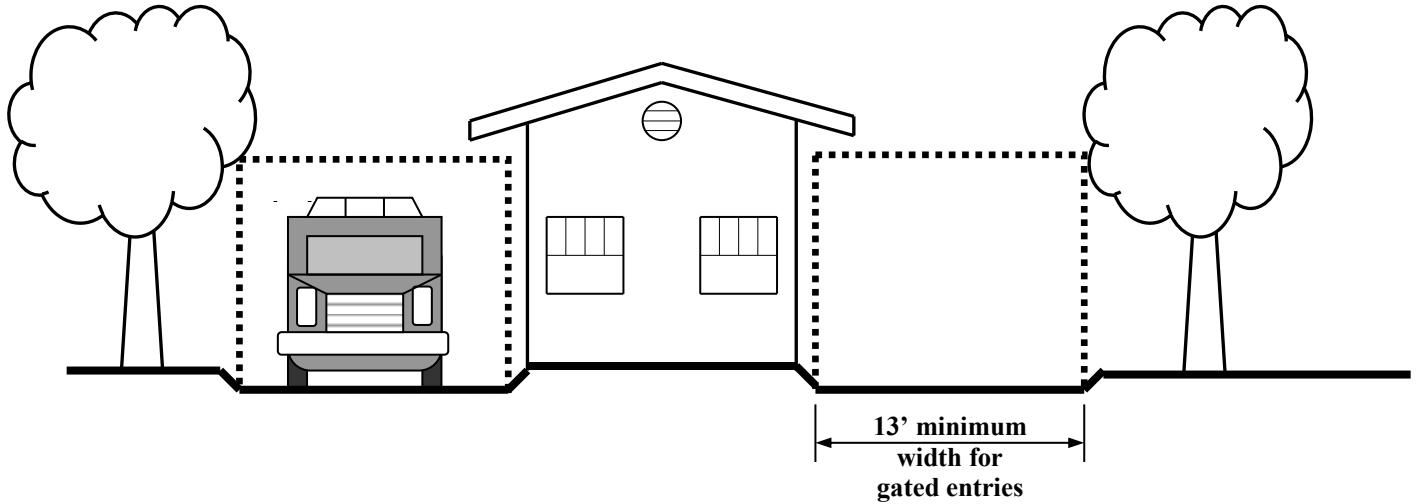

#### PROPER CLEARANCE PROVIDED

*Eaves and vegetation do not encroach upon the 13'-wide by 13'-6" high minimum dimensions allowed for the fire access roadway next to the guard house.*

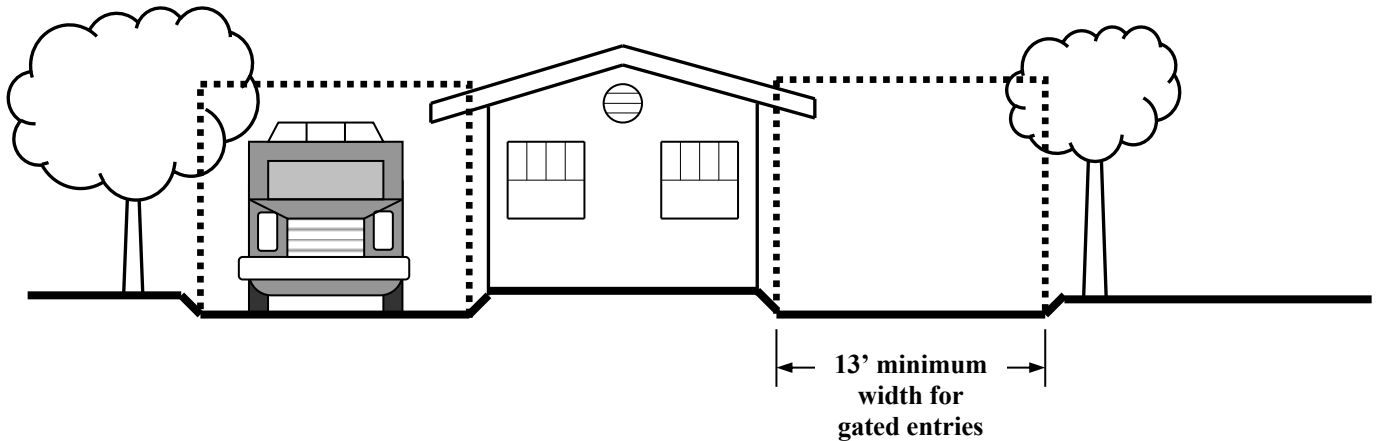

#### INSUFFICIENT CLEARANCE

*While a 13'-wide access roadway is provided next to the guard house, eaves and vegetation encroach upon the minimum clear height of the fire lane.*

## ATTACHMENT 5

### Fire Apparatus Access Roadway Clearance

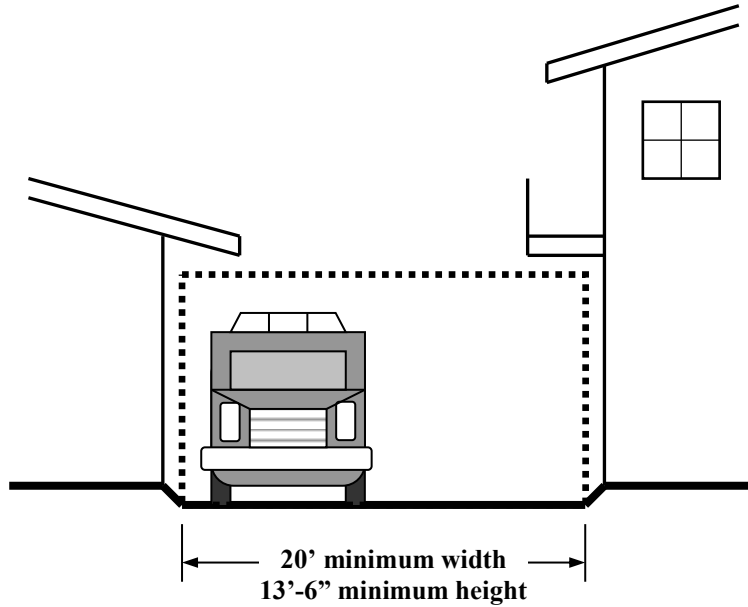

#### PROPER CLEARANCE PROVIDED

*Eaves, balconies, and other obstructions do not encroach upon the 20' wide by 13'-6" high fire access roadway envelope.*

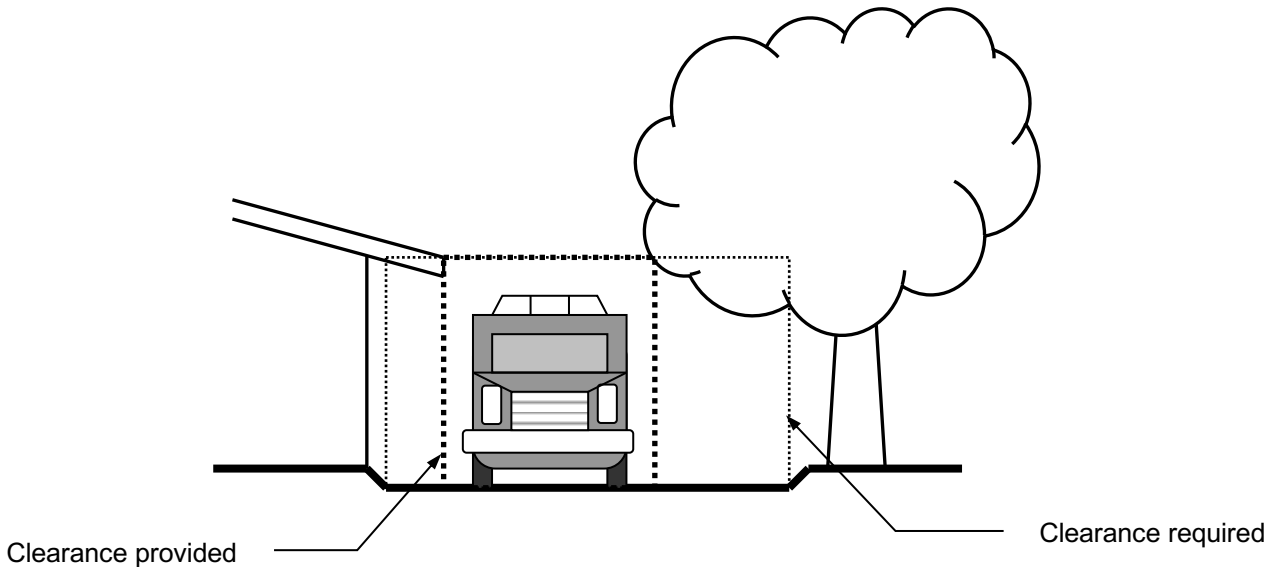

#### INSUFFICIENT CLEARANCE

*A 20'-wide roadway has been provided, but eaves and vegetation effectively reduce the clear dimensions below required minimums.*

## ATTACHMENT 6

### “S” Curves

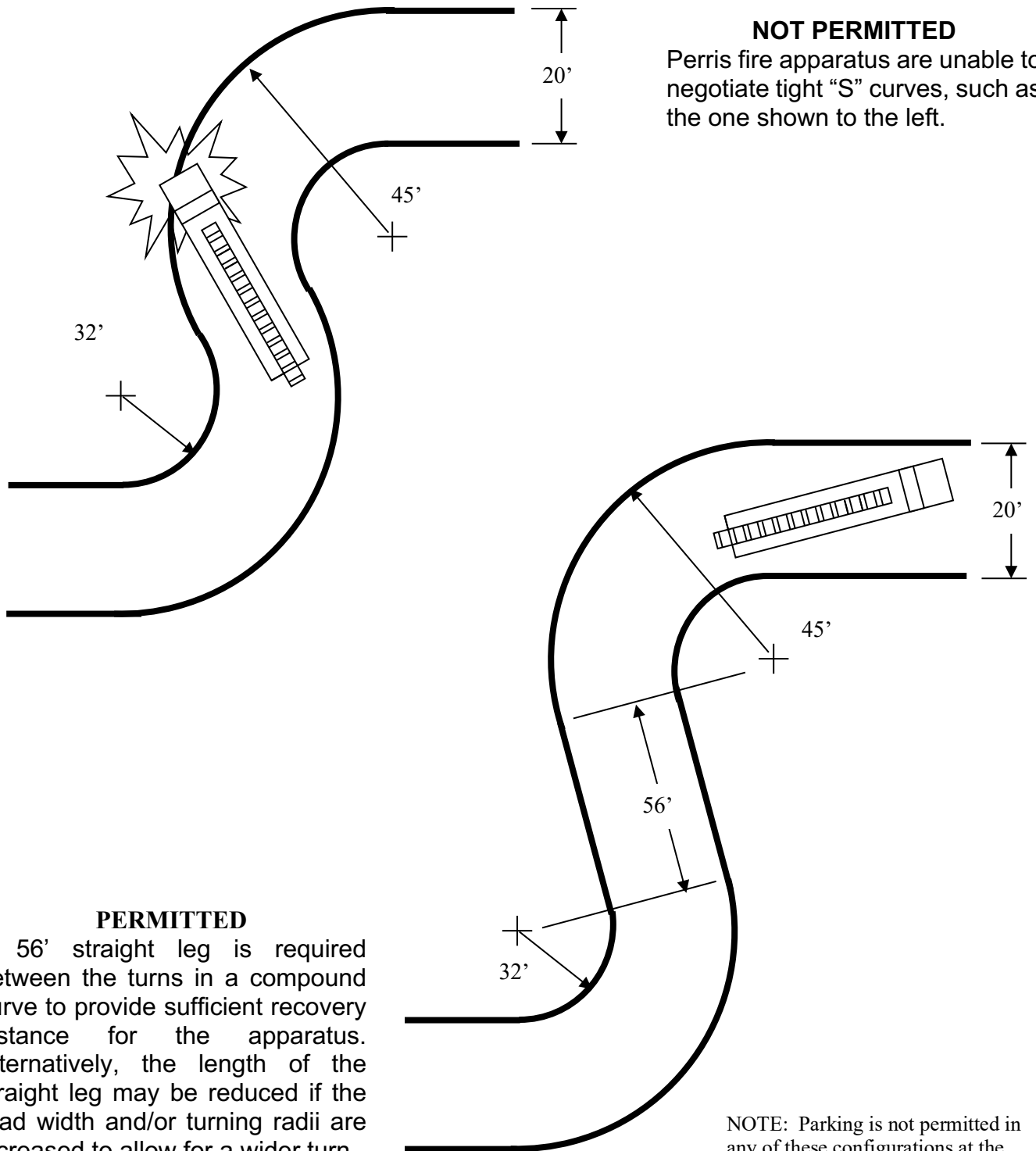

**NOT PERMITTED**  
Perris fire apparatus are unable to negotiate tight “S” curves, such as the one shown to the left.

### PERMITTED

A 56' straight leg is required between the turns in a compound curve to provide sufficient recovery distance for the apparatus. Alternatively, the length of the straight leg may be reduced if the road width and/or turning radii are increased to allow for a wider turn.

NOTE: Parking is not permitted in any of these configurations at the dimensions shown.

## ATTACHMENT 7

### Minimum Turnaround and Hammerhead Dimensions

NOTE: Parking is not permitted in these turnarounds at the dimensions shown.

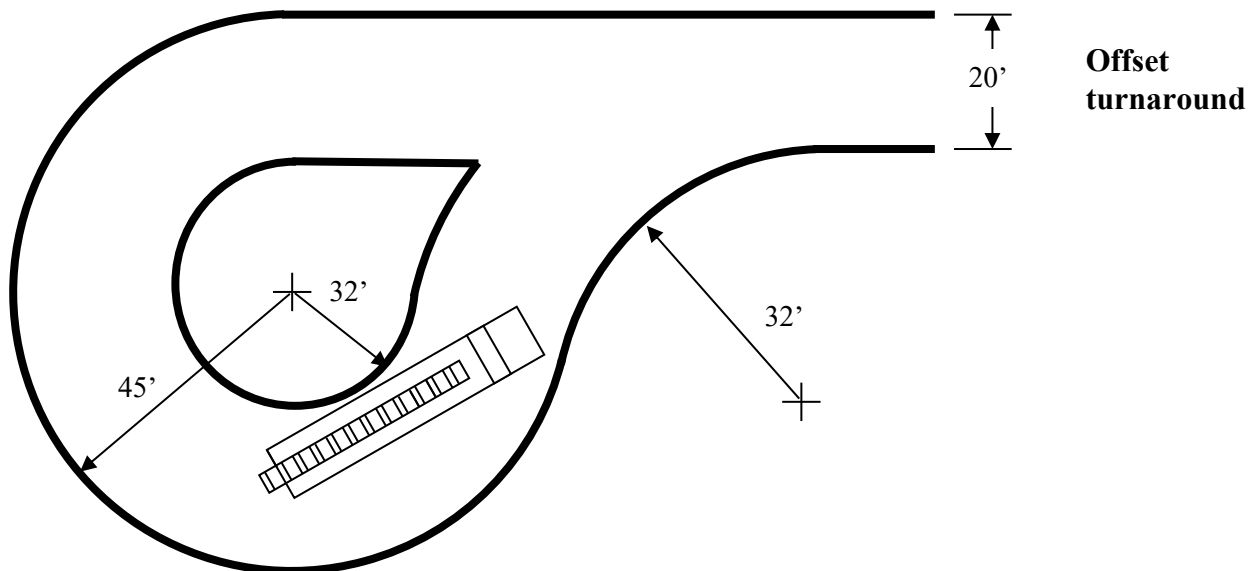
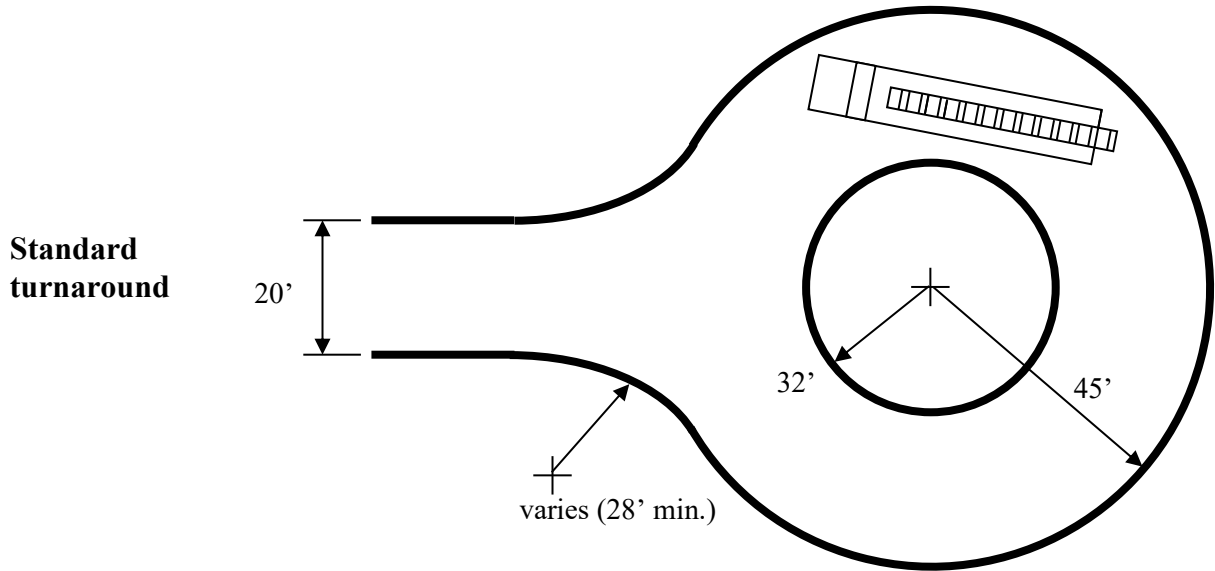

NOTE: Parking is not permitted in any of these hammerheads at the dimensions shown.

\* Wherever possible, increase this dimension by five feet.

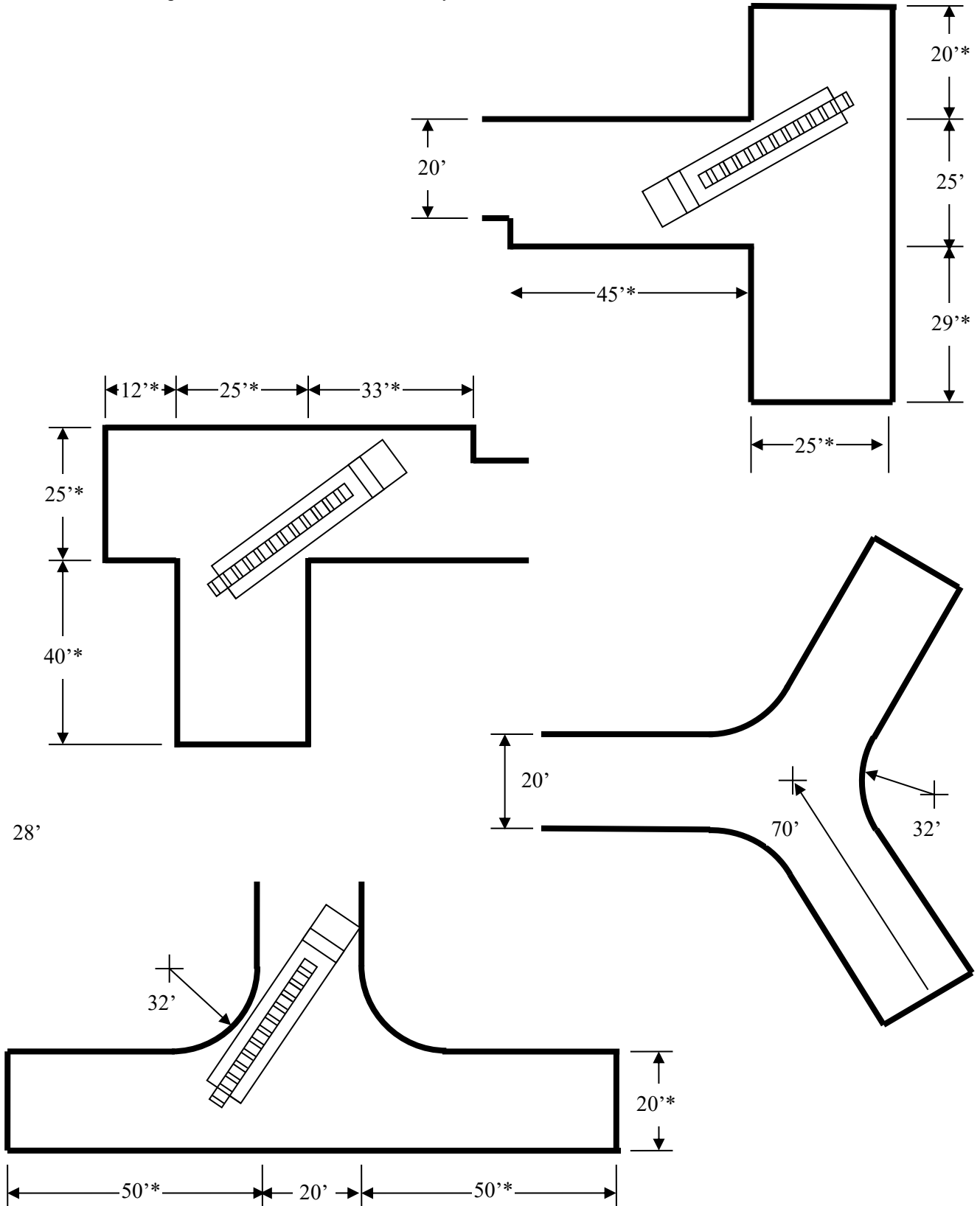



## ATTACHMENT 8

### Fire Lane Parking Violations

The California Fire Code (CFC) and California Vehicle Code (CVC) specify rules of the road for stopping, standing, and parking in fire lanes or near fire hydrants.

- A. Section 22500.1 states that no person shall stop, park, or leave standing any vehicle whether attended or unattended, in any location designated as a fire lane by the Perris Fire Prevention Bureau, except when necessary to avoid conflict with other traffic or in compliance with the direction of a peace officer or official traffic control device. Vehicles illegally parked in a fire lane may be towed per CVC 22953(b).
- B. There shall be no parking of any vehicles other than fire department vehicles within 15 feet of either side of a fire hydrant in accordance with CVC 22514(c). Such vehicles may be towed per CVC 22651(e).
- C. CVC 22658(a) permits the owner or person in lawful possession of any private property, subsequent to notifying local law enforcement, to cause the removal of a vehicle parked on such property to the nearest public garage, if:
  - 1) A sign is displayed in plain view at all entrances to the property specifying:
    - a) The ordinance prohibiting public parking, *and*
    - b) A notation indicating that vehicles will be removed at the owner's expense, *and*
    - c) The telephone number of the local traffic law enforcement agency, *or*
  - 2) The lot or parcel upon which the vehicle is parked has a single-family dwelling.
- D. CFC 503.4 states that the required width of a fire apparatus access road shall not be obstructed in any manner, including parking of vehicles. Minimum required widths and clearances shall be maintained at all times.
- E. CFC 507.5.4 states that vehicles and other obstructions shall not be placed or kept near fire hydrants, fire department inlet connections or fire-protection system control valves in a manner that would prevent such equipment or fire hydrants from being immediately discernible. The fire department shall not be deterred or hindered from gaining immediate access to fire-protection equipment or hydrants.

## ATTACHMENT 9

### Fire Lane Identification – Red Curbs

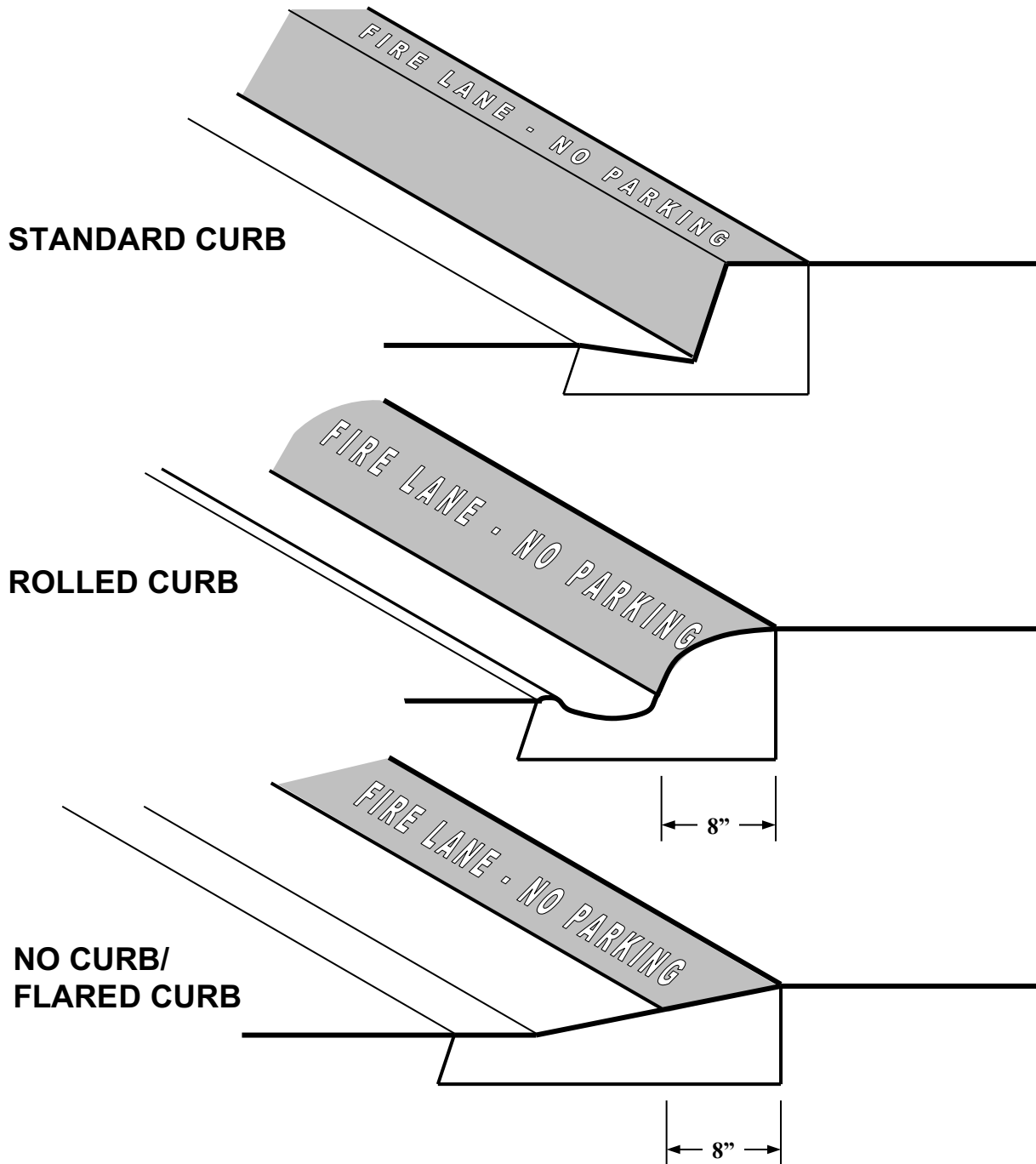

1. Fire lane entrance sign(s) shall also be provided per Attachment 10 or 11.
2. Curbs shall be painted OSHA safety red.
3. "FIRE LANE – NO PARKING" shall be painted on top of curb in 3" white lettering at a spacing of 30' on center or portion thereof.

## ATTACHMENT 10

### Specifications for Fire Lane Entrance Signs

To be used only at *vehicle entry points*  
to areas that contain “Fire Lane—No Parking” signs or red curbs

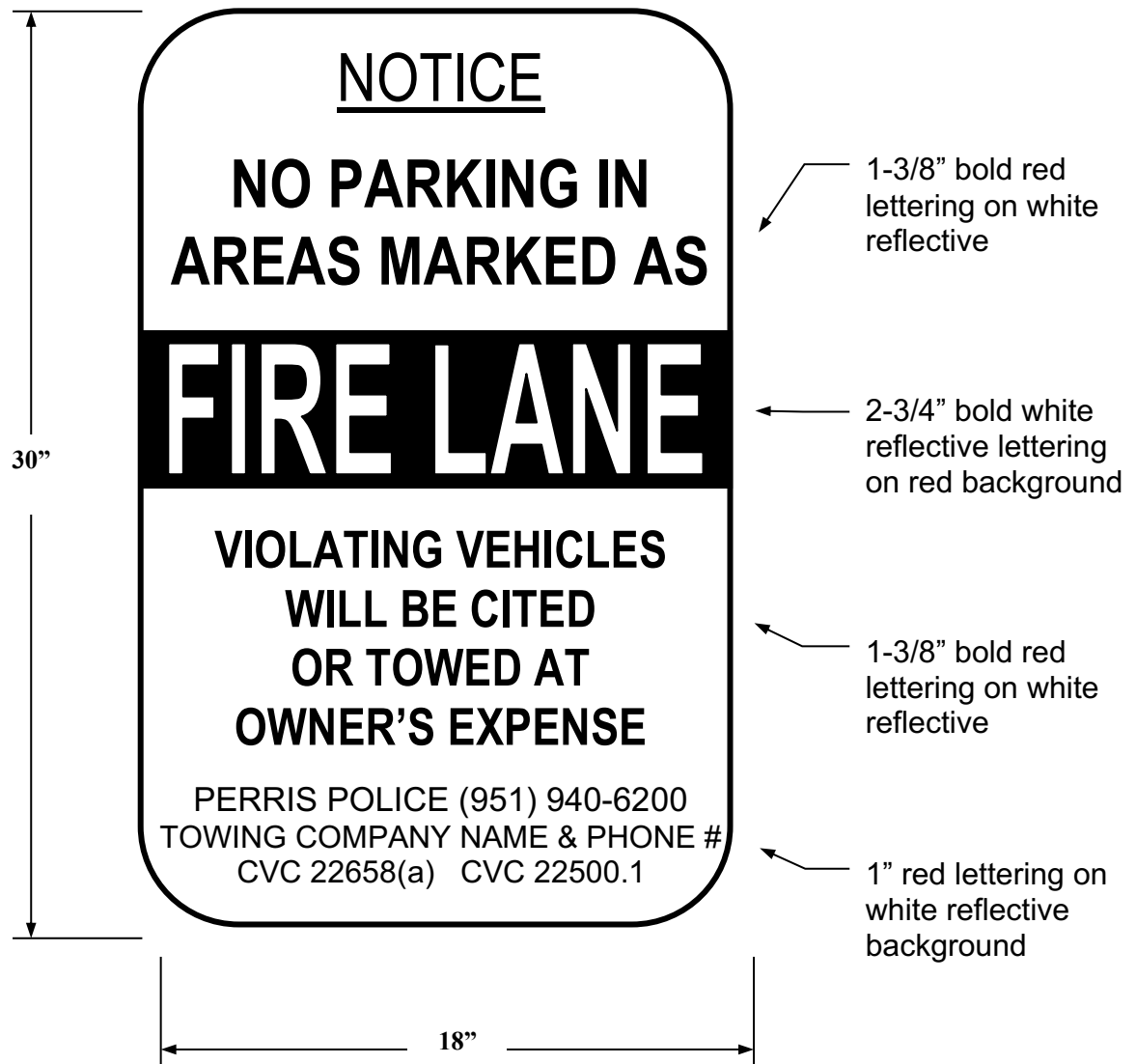

All sign and lettering dimensions shown are minimums. “Arial Narrow” font used is used in sample above though other legible sans-serif fonts may be acceptable.

This sign shall be posted at all vehicle entrances to areas marked with either red curbs or fire lane “No Parking” signs. Signs shall be securely mounted facing the direction of travel and clearly visible to oncoming traffic entering the designated area. Signs shall be made of durable material and installed per Attachments 13 and 14.

Towing company contact information is required for all properties with a standing written agreement for services with a towing company per the California Vehicle Code.

## ATTACHMENT 11

### Specifications for Alternate Location of Towing Company Information



Fire lane entrance sign shall meet all Perris standards detailed in this guideline

Minimum 1" red lettering on white reflective background

Towing company contact information is required for all properties with a standing written agreement for services with a towing company per the California Vehicle Code.

To facilitate periodic changes in towing company contracts, the towing company contact information may be posted on a separate sign mounted directly below the fire lane entrance sign instead of on the entrance sign itself. The method of attachment to the post shall not obscure the wording on either sign.

## ATTACHMENT 12

### Specifications for Fire Lane No Parking Signs

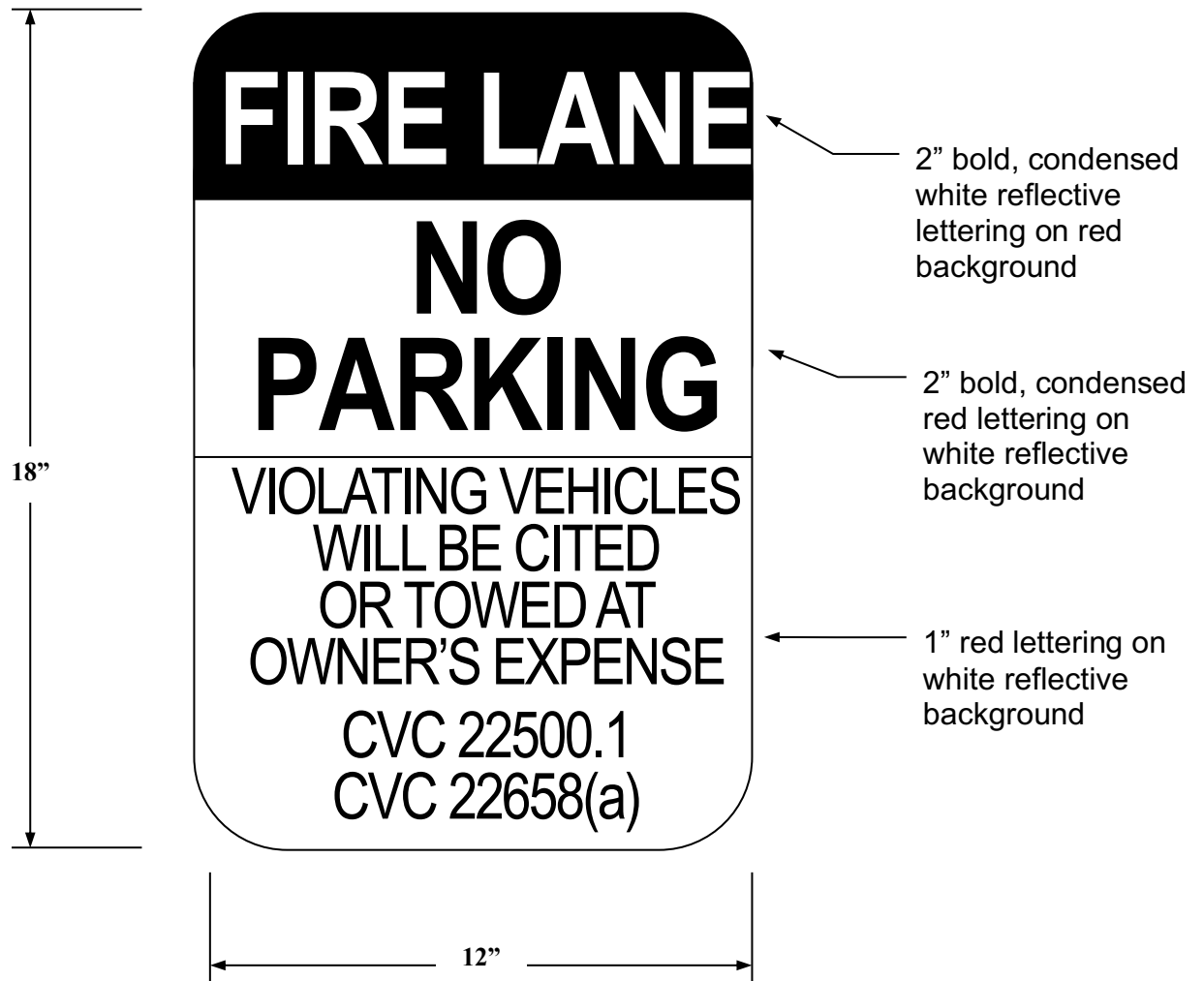

All sign and lettering dimensions shown are *minimums*. "Arial Narrow" font used is used in sample above though other legible sans-serif fonts may be acceptable.

Signs shall be securely mounted facing the direction of travel and clearly visible to oncoming traffic entering the designated area. Signs shall be made of durable material and installed per Attachments 13 and 14.

## ATTACHMENT 12a

### Specifications for Cul-de-Sac Fire Lane No Parking Signs

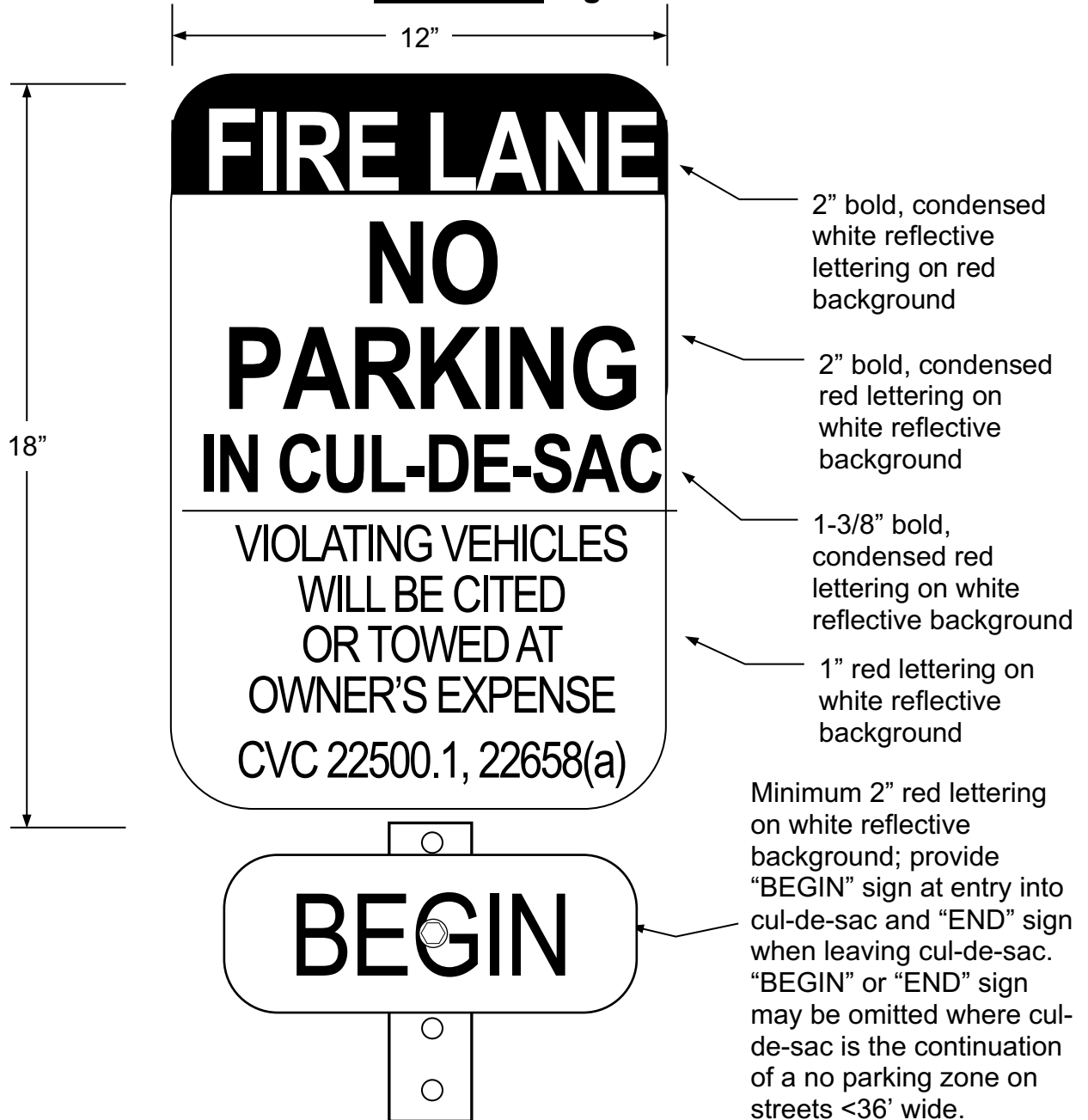

All sign and lettering dimensions shown are *minimums*. "Arial Narrow" font used is used in sample above though other legible sans-serif fonts may be acceptable.

Signs shall be securely mounted facing the direction of travel and clearly visible to oncoming traffic entering the designated area. Signs shall be made of durable material and installed per Attachments 13 and 14.

## ATTACHMENT 12b

### Specifications for Alternative Fire Lane No Parking Signs



← Additional verbiage shall be 1" bold, condensed red lettering on white reflective background. Where parking stalls are not present, sign may omit "except in designated stalls" and sign height may be reduced to 18".

Specifications for the rest of the sign shall match those of standard fire lane no parking signs.

All sign and lettering dimensions shown are *minimums*. "Arial Narrow" font used is used in sample above though other legible sans-serif fonts may be acceptable.

Signs shall be securely mounted facing the direction of travel and clearly visible to oncoming traffic entering the designated area. Signs shall be made of durable material and installed per Attachments 13 and 14.

# ATTACHMENT 13

## Fire Lane No Parking Sign Locations

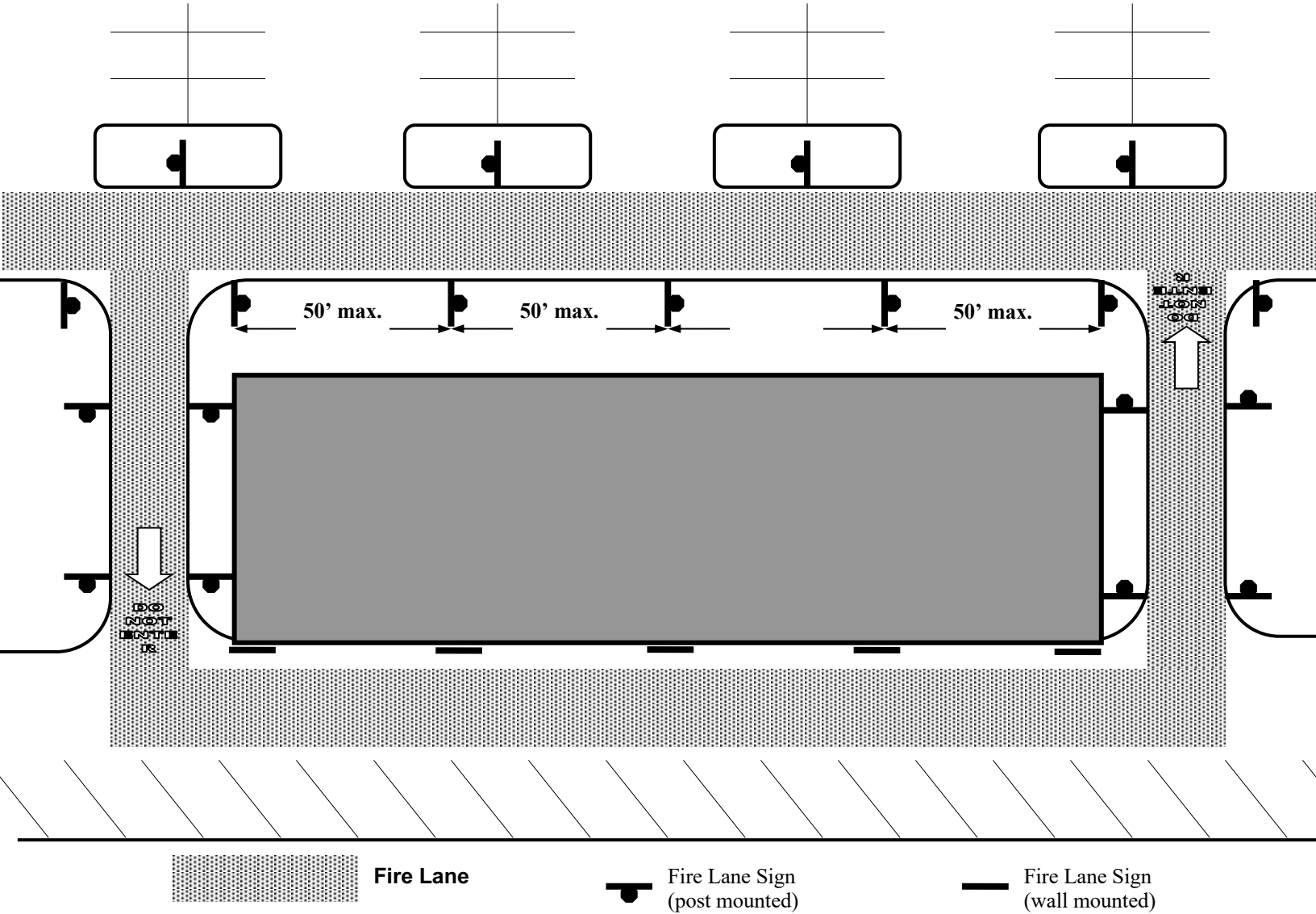

Signs are required within 3' of the end of each designated fire lane and spaced a maximum of 50' along the entire designated lane. One sign is required for each island adjacent to the fire lane.

Signs shall be securely mounted facing the direction of travel and clearly visible to oncoming traffic entering the designated area. Signs shall be made of durable material and installed per Attachment 14. Where sign posts are not practical, signs may be mounted on a wall or fence. Perris inspectors will determine if additional signs or sign locations are required.



# ATTACHMENT 13a

## Fire Lane No Parking Sign Locations for Cul-de-sacs

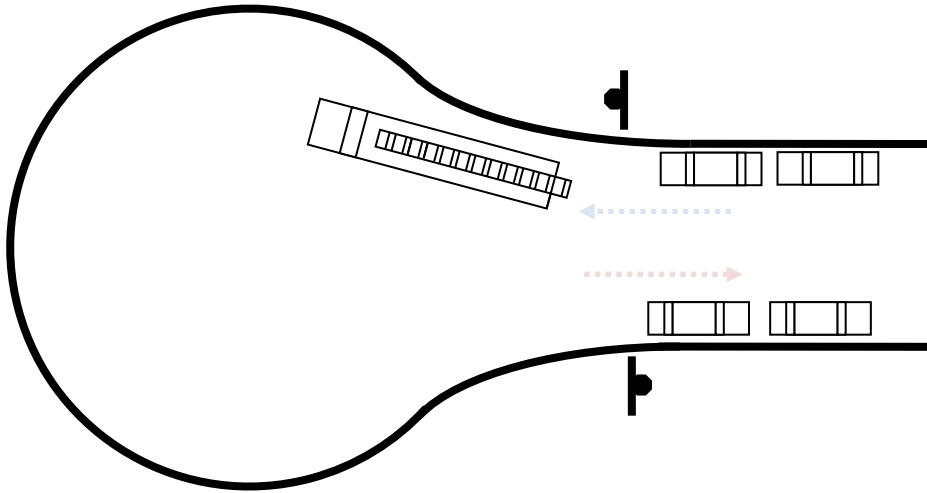

**Standard 45' radius cul-de-sac**  
“no-parking entire cul-de-sac begin”  
and “end” signs shall be located at the  
point where the street begins to widen  
into the bulb (see Attachment 12a)

**Offset 45' radius cul-de-sac:** “no-parking  
entire cul-de-sac begin” and “end” signs  
shall be located at the point where the street  
begins to widen into the bulb and at a point  
45' from where the cul-de-sac and street are  
tangent (see Attachment 12a)

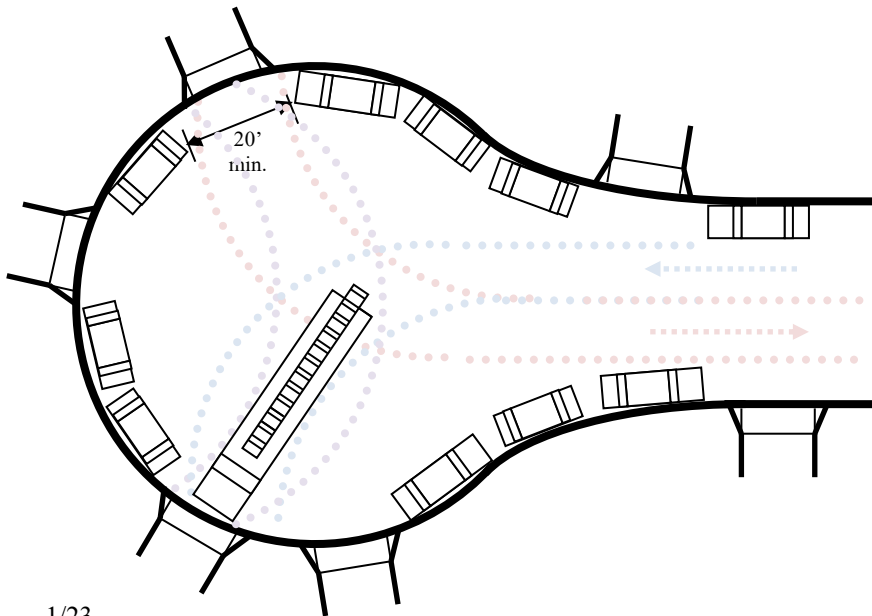
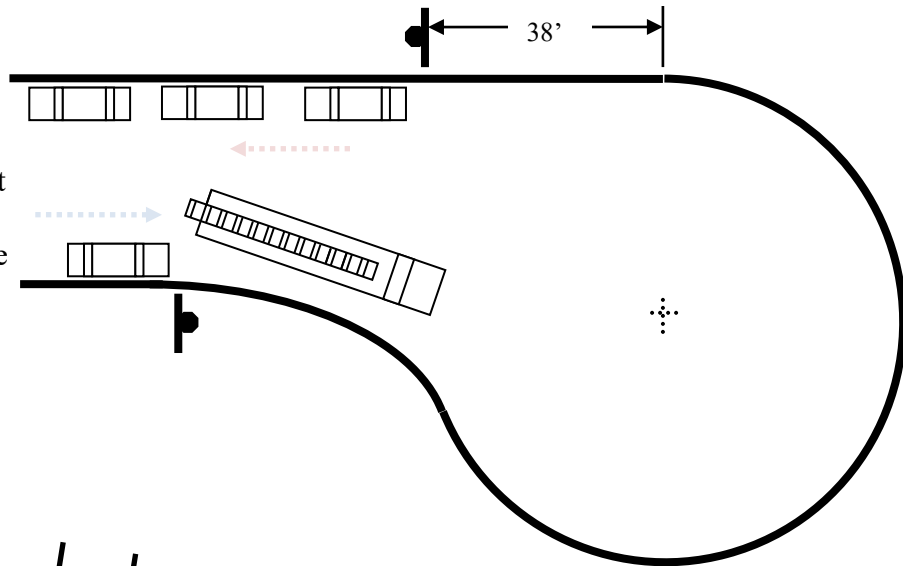

Where size and placement of driveways  
ensure sufficient space is available to execute  
a three-point turn, no-parking signs are  
unnecessary.

## ATTACHMENT 14

### Mounting Specifications for Fire Lane Entrance and No Parking Signs

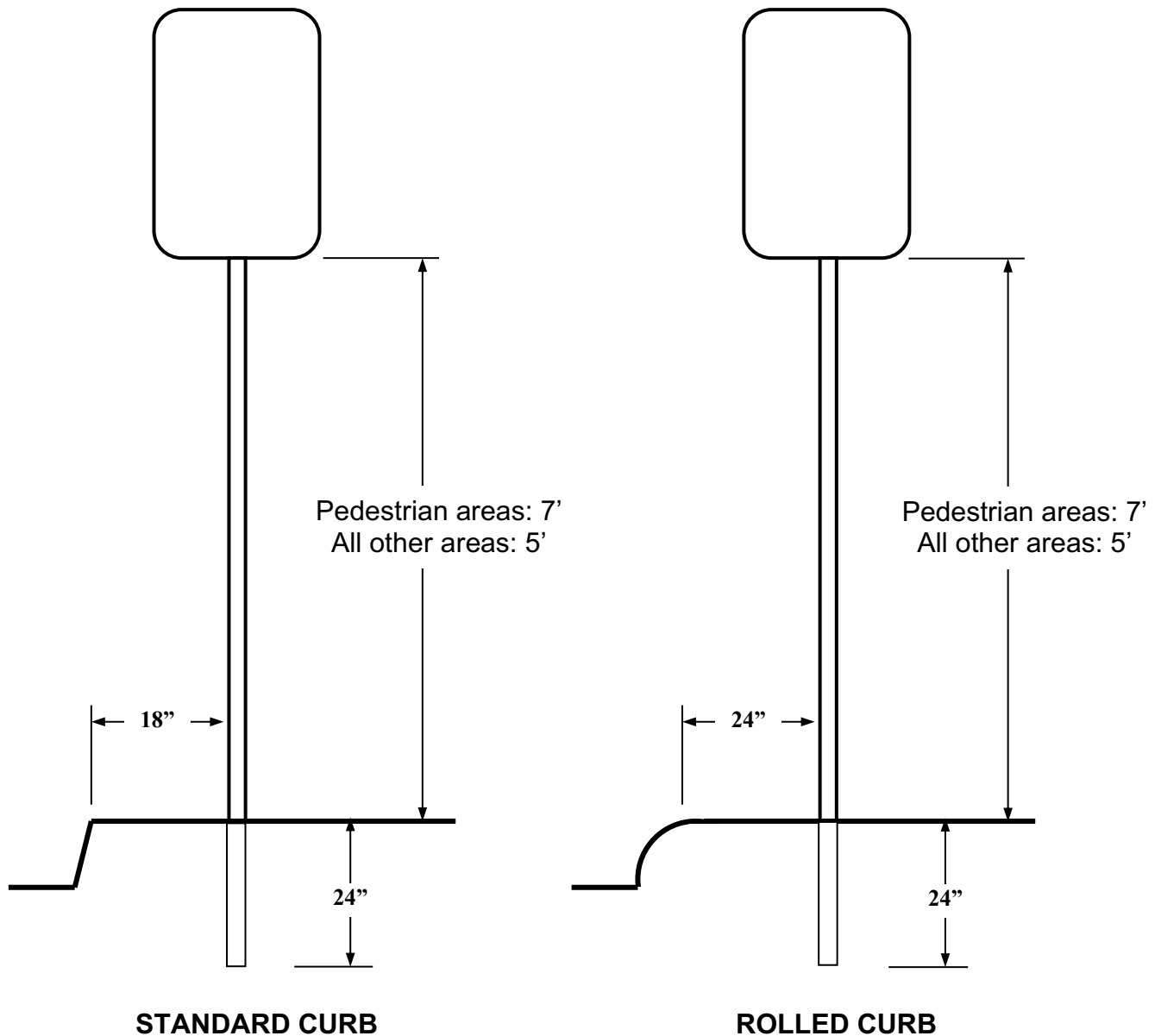

Signs shall be mounted facing the direction of vehicular travel.

Signs may be mounted on existing posts or buildings where the centerline of the sign is no more than 24" from the edge of the roadway.

Depth of bury shall be a *minimum* of 24" and rebar, a concrete footing, or another method to prevent removal of the sign is recommended. Footings for signs located in the public right-of-way shall be per the local jurisdiction's requirements.

---

# ATTACHMENT 15

## Minimum Gate Setbacks

---

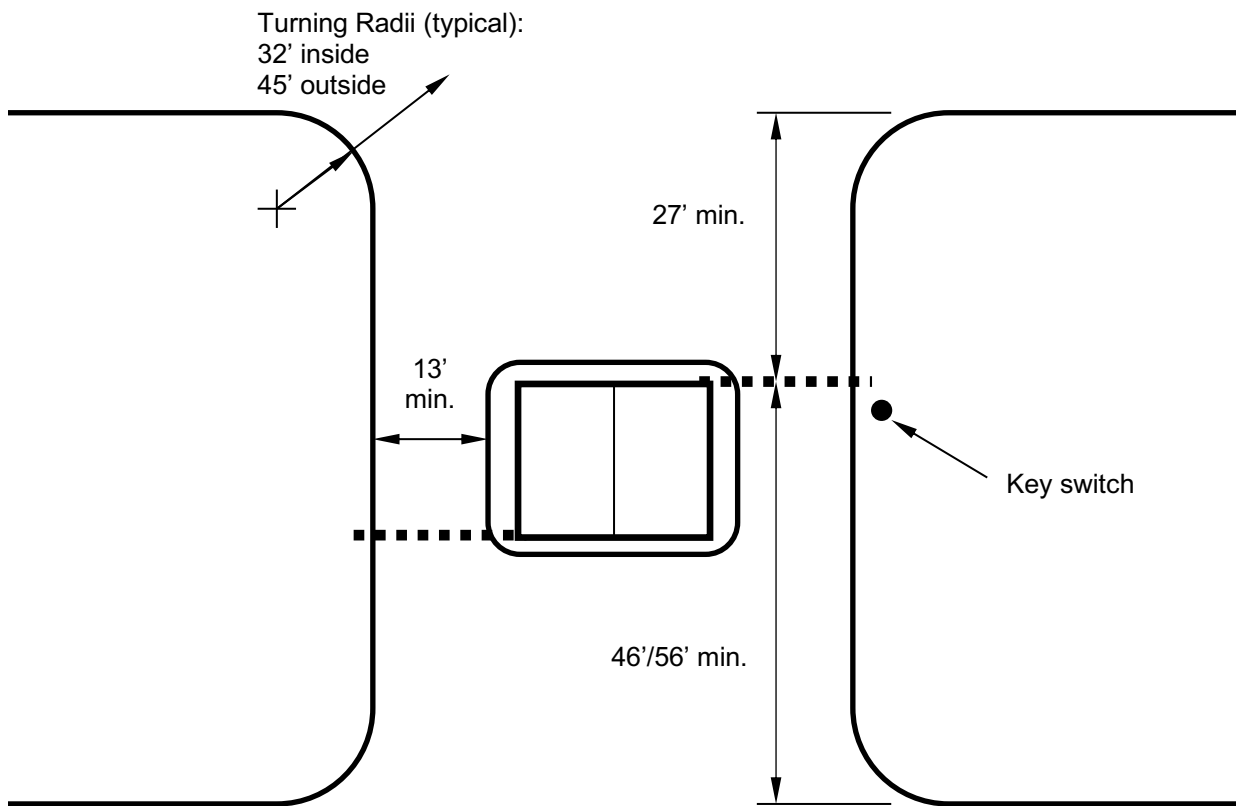

## ATTACHMENT 16

### Specifications for “Fire Lane - No Parking” Signs for Manually Operated Gates and Barriers

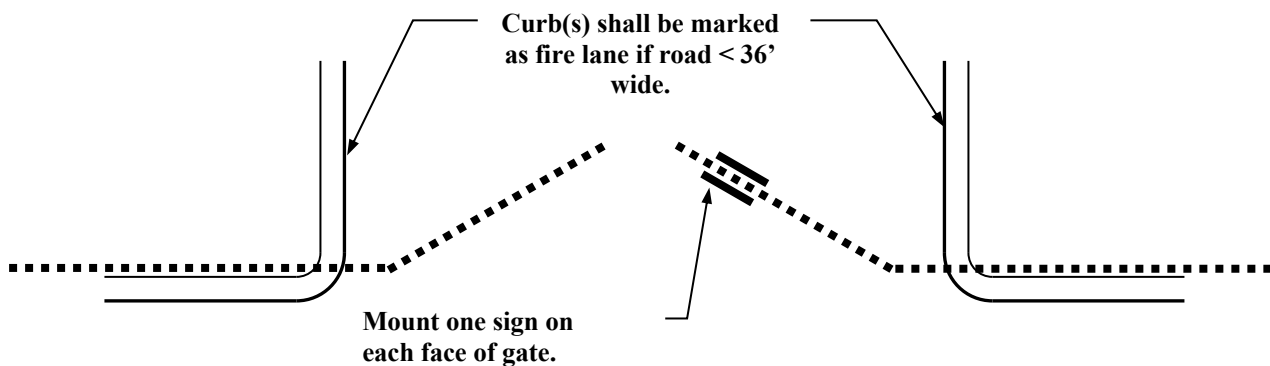
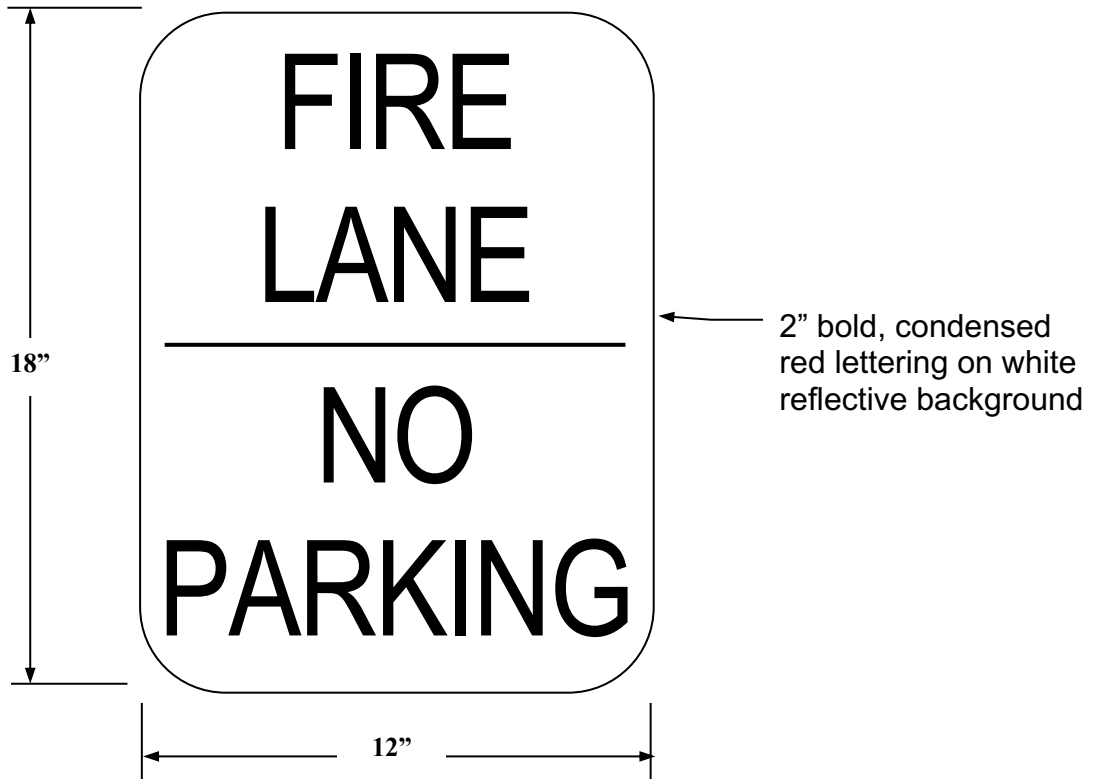

All sign and lettering dimensions shown are minimums. “Arial Narrow” font used is used in sample above though other legible sans-serif fonts may be acceptable.

“Fire Lane—No Parking” sign shown in Attachment 12 may be used as an alternative. Signs shall be securely mounted on the front and back face of the gate clearly visible to traffic entering the designated area. Signs shall be made of a durable material.

## ATTACHMENT 17

### Cul-de-sacs and Dead-end Roadways

- 1) Cul-de-sac streets greater than 150 feet in length that are required fire lanes shall be provided with a 45-foot minimum turning radius in the bulb.

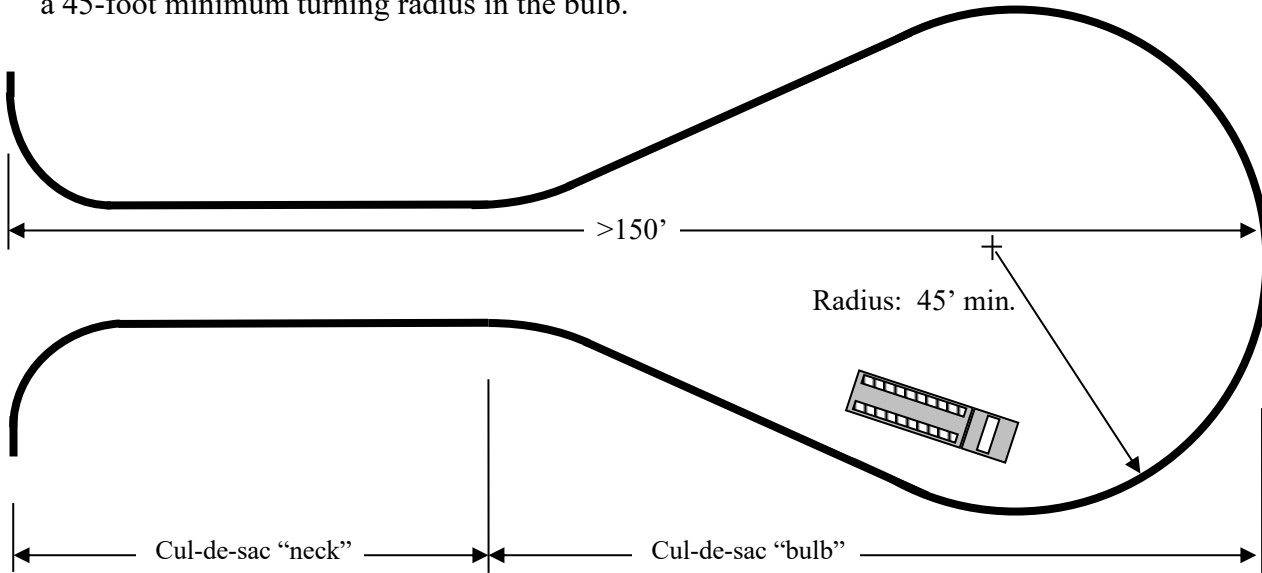

- 2) Where a spur road or private driveway that is a required fire lane is accessed via the cul-de-sac road, the driveway or spur shall be no more than 150' in length unless an approved turnaround has been provided within 150' of the end of the spur or driveway.

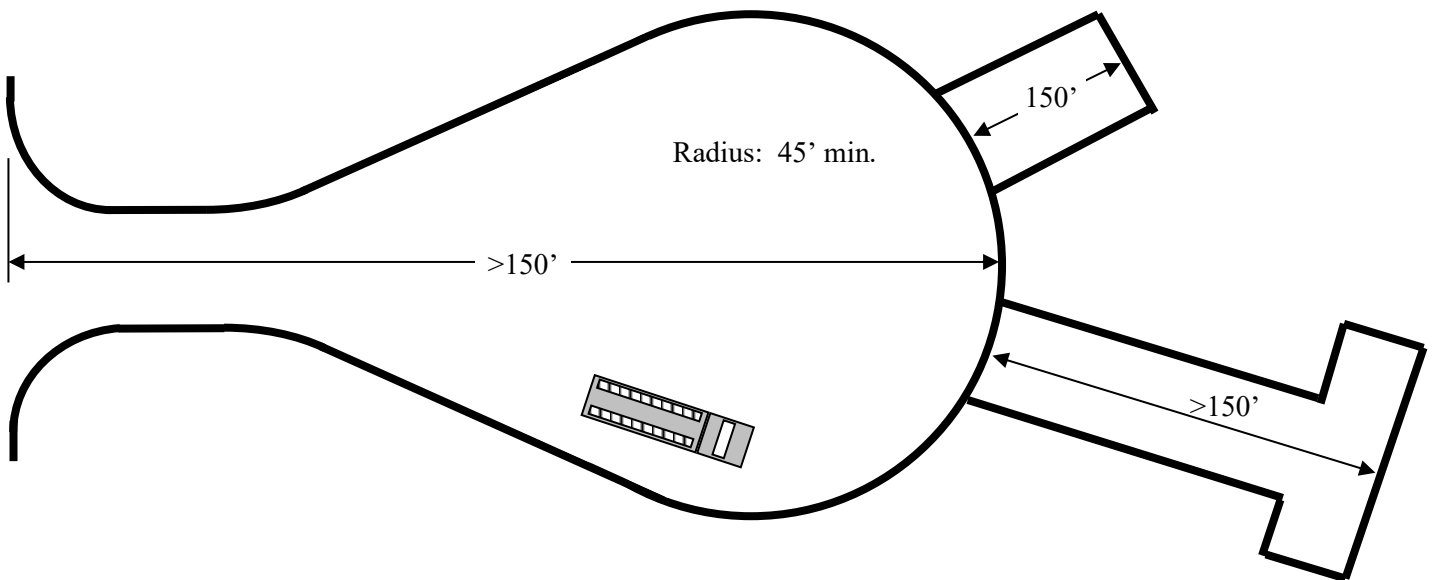

*Drawing  
not to scale*

## ATTACHMENT 18

### Sample Parking Enforcement Letter

Date

Office of the Fire Marshal  
City of Perris  
135 N. "D" Street  
Perris, CA. 92570

Re: *(Project Name, Location, and Permit Number)*  
Parking Enforcement Plan

The fire lane parking enforcement plan for the above referenced project is stated as follows:

All fire lanes within *(list development address or tract information)* shall be maintained and in no event shall parking be permitted along any portion of a street or drive that required fire lanes or any area designated as a fire lane for turn-around purposes either during construction or after occupancy.

*(Association name)* shall adopt reasonable rules and regulations regarding the parking of vehicles along the streets, roads and or drives within the project that are not in conflict with applicable law.

In furtherance thereof, *(Association name)*, through its officers, committees and agents, will establish the "parking" and "no parking" areas within the property in accordance with Section 22658.2 of the California Vehicle Code and Perris Fire Prevention Bureau Access & Water Guideline. The law shall be enforced through such rules and regulations by all lawful means, including, written warnings, citing, levying fines and towing vehicles in violation.

*(Association name)* will contract with a certified patrol and towing company to remove vehicles that violate no parking restrictions. First time violators will receive a written warning and with subsequent violations, the vehicle shall be subject to towing. The vehicle owner shall be responsible for all costs incurred in remedying such violation, including without limitation towing cost, citations and legal fees.

Company Name  
Authorized Agent Signature

Cc:

## ATTACHMENT 19

### CFC TABLE B105.1: Minimum Required Fire Flow and Flow Duration for Buildings as adopted by the City of Perris

FIRE FLOW CALCULATION AREA (square feet)					FIRE FLOW (gallons/min)		Flow Duration
Type IA and IB	Type IIA and IIIA	Type IV and VA	Type IIB and IIIB	Type VB	unsprinklered commercial/SFR	sprinklered commercial/SFR	
0-22700	0-12700	0-8200	0-5900	0-3600	1500/1000	1500/1000	2
22701-30200	12701-17000	8201-10900	5901-7900	3601-4800	1750	1500/1000	
30201-38700	17001-21800	10901-12900	7901-9800	4801-6200	2000	1500/1000	
38701-48300	21801-24200	12901-17400	9801-12600	6201-7700	2250	1500/1125	
48301-59000	24201-33200	17401-21300	12601-15400	7701-9400	2500	1500/1250	
59001-70900	33201-39700	21301-25500	15401-18400	9401-11300	2750	1500/1375	3
70901-83700	39701-47100	25501-30100	18401-21800	11301-13400	3000	1500	
83701-97700	47101-54900	30101-35200	21801-25900	13401-15600	3250	1625	
97701-112700	54901-63400	35201-40600	25901-29300	15601-18000	3500	1750	
112701-128700	63401-72400	40601-46400	29301-33500	18001-20600	3750	1875	
128701-145900	72401-82100	46401-52500	33501-37900	20601-23300	4000	2000	4
145901-164200	82101-92400	52501-59100	37901-42700	23301-26300	4250	2125	
164201-183400	92401-103100	59101-66000	42701-47700	26301-29300	4500	2250	
183401-203700	103101-114600	66001-73300	47701-53000	29301-32600	4750	2375	
203701-225200	114601-126700	73301-81100	53001-58600	32601-36000	5000	2500	
225201-247700	126701-139400	81101-89200	58601-65400	36001-39600	5250	2625	
247701-271200	139401-152600	89201-97700	65401-70600	39601-43400	5500	2750	
271201-295900	152601-166500	97701-106500	70601-77000	43401-47400	5750	2875	
295901+	166501+	106501-115800	77001-83700	47401-51500	6000	3000	
		115801-125500	83701-90600	51501-55700	6250	3125	
		125501-135500	90601-97900	55701-60200	6500	3250	
		135501-145800	97901-106800	60201-64800	6750	3375	
		145801-156700	106801-113200	64801-69600	7000	3500	
		156701-167900	113201-121300	69601-74600	7250	3625	
		167901-179400	121301-129600	74601-79800	7500	3750	
		179401-191400	129601-138300	79801-85100	7750	3875	
		191401+	138301+	85101+	8000	4000	

Minimum fire flow for a detached, unsprinklered single-family residence/duplex up to 3600 sq.ft. is 1000 gpm.

Construction Types shall be based upon actual construction without applying 1-hour equivalency allowed by CBC Table 601 footnote 'e'.

Fire flow measured at 20 psi.

# ATTACHMENT 20

**CFC TABLE B105.1:  
Hydrant Quantity Based on Fire Flow**

<b>FIRE-FLOW REQUIREMENT (gpm)</b>	<b>MINIMUM NUMBER OF HYDRANTS</b>
1,750 or less	1
1,751–2,250	2
2,251–3,250	3
3,251–4,000	4
4,001–5,000	5
5,001–5,500	6
5,501–6,000	6
6,001–7,000	7
7,001 or more	8 or more <sup>c</sup>



# ATTACHMENT 21

## Protection of Hydrants, Detector Checks, Fire Department Connections, and other Appurtenances

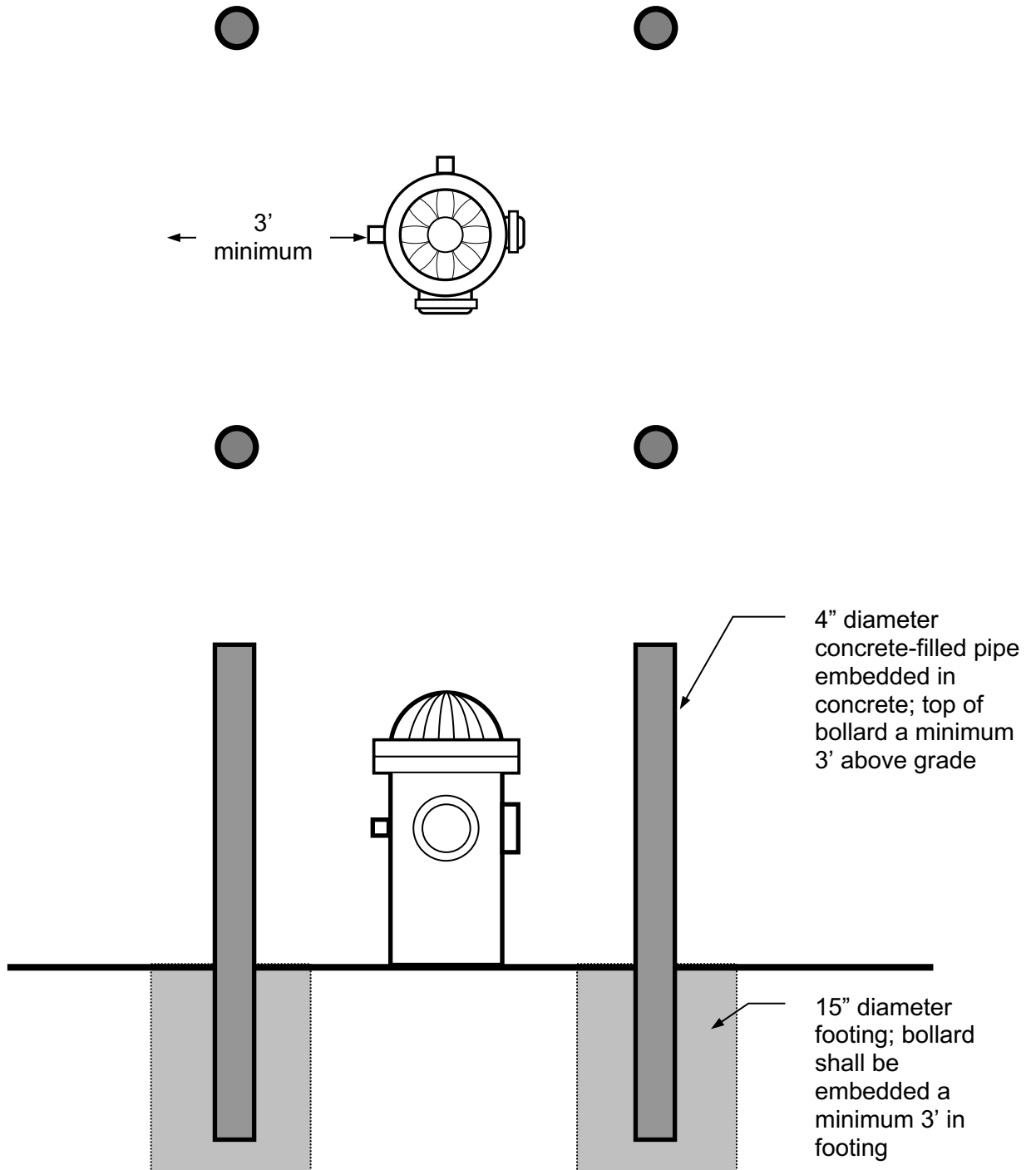

# ATTACHMENT 22

## Blue Dot Hydrant Marker Location

TWO LANE STREET

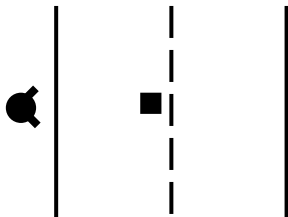

MULTI-LANE STREET

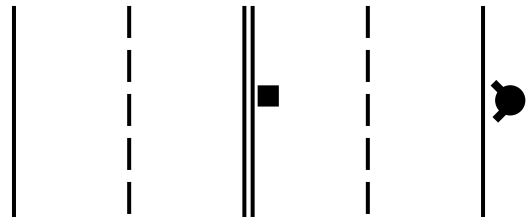

INTERSECTION

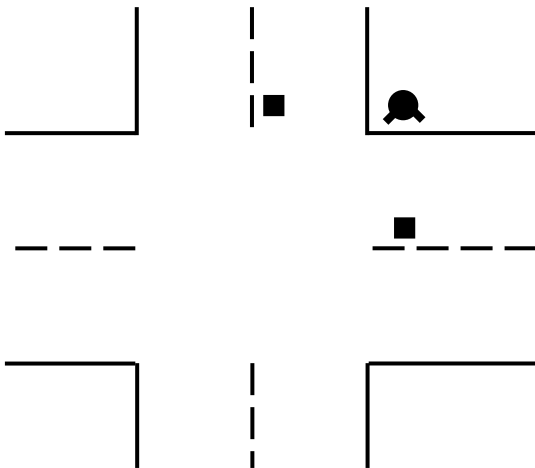

INTERSECTION WITH TURN LANES

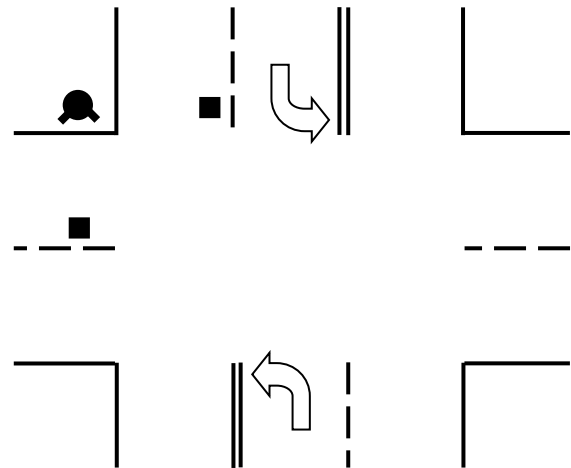

MULTILANE STREET WITH TURN LANE

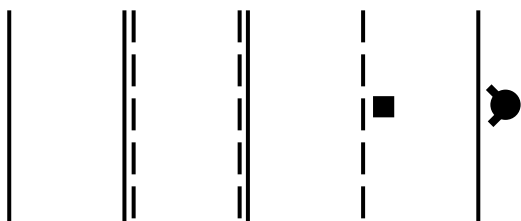

FREEWAYS AND EXPRESSWAYS

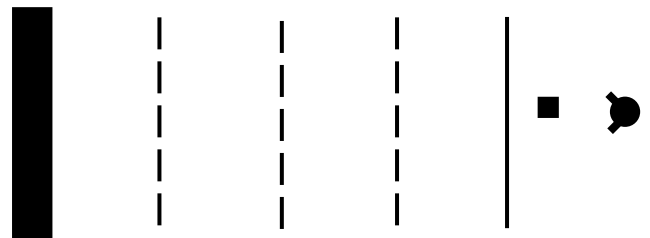

The developer may contact the local water company to arrange the installation of the blue dots. If the water agency does not participate in the blue dot program, the developer is still responsible to install the dots in an approved manner.

## ATTACHMENT 23

### Hose Pull

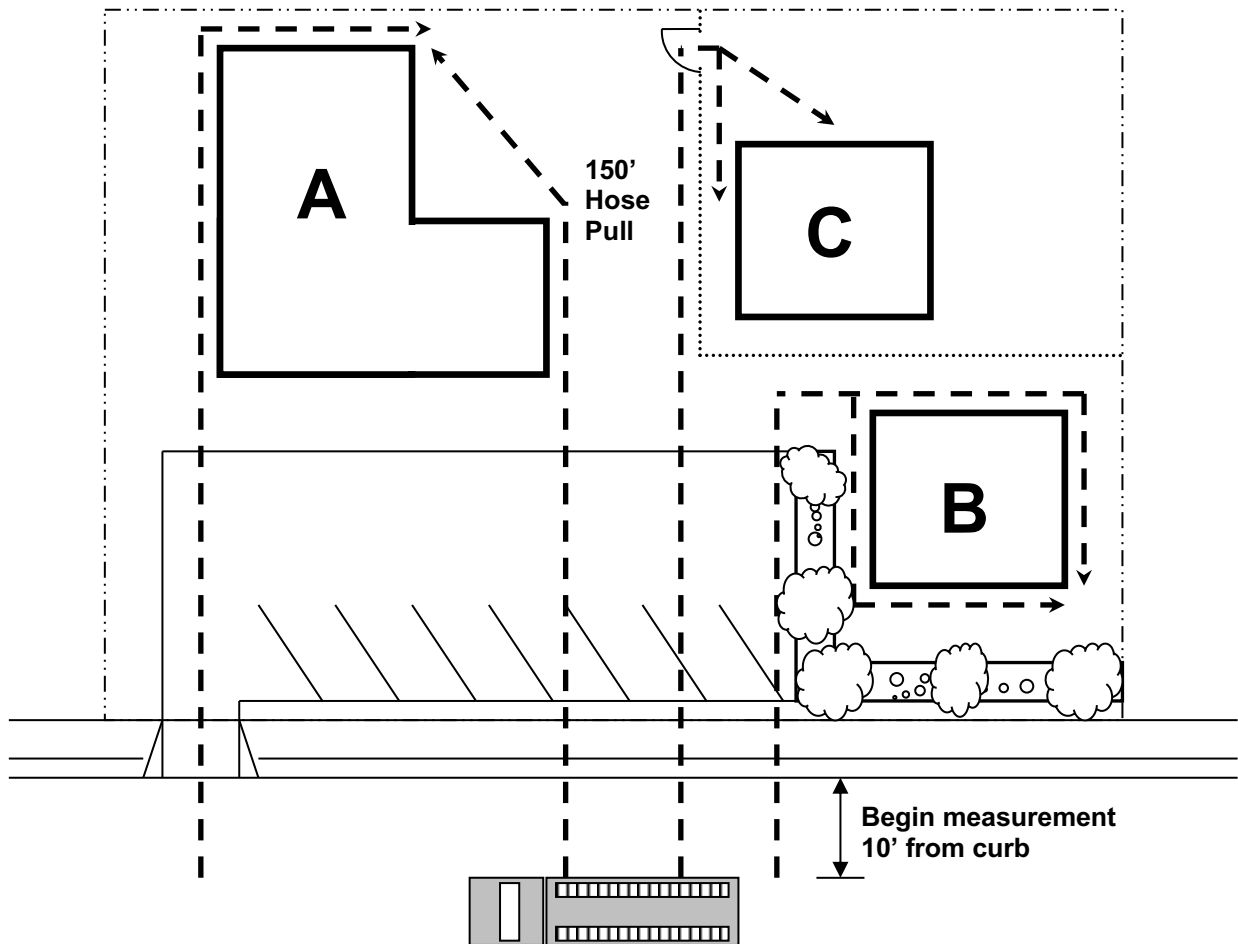

In the example above, assume that the parking lot is not accessible to fire apparatus due to turning radii and fire lane widths less than the required minimums.

- All portions of building “A” are within 150’ feet of the public road as measured along the path of firefighter travel. This building is in access.
- Building “B” is also in access despite the obstruction presented by the planter and hedges.
- Building “C” is out of access; the presence of a chainlink fence forces firefighters to backtrack once they pass through the gate, increasing their travel distance beyond 150’. On-site fire access roadways or a change in the location of the gate and would be necessary to provide access to Building “C”.